

GENERAL INFORMATION

POWER-STUD® + SD1

Wedge Expansion Anchor

PRODUCT DESCRIPTION

The Power-Stud+ SD1 anchor is a fully threaded, torque-controlled, wedge expansion anchor which is designed for consistent performance in cracked and uncracked concrete. Suitable base materials include normal-weight concrete, sand-lightweight concrete, concrete over steel deck, and grouted concrete masonry. The anchor is manufactured with a zinc plated carbon steel body and expansion clip for premium performance. Nut and washer are included.

GENERAL APPLICATIONS AND USES

- Structural connections, i.e., beam and column anchorage
- Safety-related attachments
- Protective barriers and racking
- Tension zone applications, i.e., cable trays and strut, pipe supports, fire sprinklers
- Seismic and wind loading
- Interior applications / low level corrosion environment

FEATURES AND BENEFITS

- + Consistent performance in high and low strength concrete
- + Nominal drill bit size is the same as the anchor diameter
- + Anchor can be installed through standard fixture holes
- + Length ID code and identifying marking stamped on head of each anchor
- + Anchor design allows for follow-up expansion after setting under tensile loading

APPROVALS AND LISTINGS

- International Code Council, Evaluation Service (ICC-ES), ESR-2818 for cracked and uncracked concrete
- International Code Council, Evaluation Service (ICC-ES), ESR-2966 for masonry
- Code compliant with the 2015 IBC, 2015 IRC, 2012 IBC, 2012 IRC, 2009 IBC, and 2009 IRC
- Tested in accordance with ACI 355.2/ASTM E 488 and ICC-ES AC193 for use in structural concrete under the design provisions of ACI 318-14 Chapter 17 or ACI 318-11/08 Appendix D
- Evaluated and qualified by an accredited independent testing laboratory for recognition in cracked and uncracked concrete including seismic and wind loading (Category 1 anchors)
- Tested in accordance with ICC-ES AC01 for use in masonry
- Underwriters Laboratories (UL Listed) - File No. EX1289, see listing for sizes

GUIDE SPECIFICATIONS

CSI Divisions: 03 16 00 - Concrete Anchors, 04 05 19.16 - Masonry Anchors and 05 05 19 - Post-Installed Concrete Anchors. Expansion anchors shall be Power-Stud+ SD1 as supplied by DEWALT, Towson, MD. Anchors shall be installed in accordance with published instructions and the Authority Having Jurisdiction.

MATERIAL SPECIFICATIONS

| Anchor component | Specification |
|------------------------|--|
| Anchor Body | Medium carbon steel |
| Hex nut | Carbon steel, ASTM A 563, Grade A |
| Washer | Carbon Steel, ASTM F 844; meets dimensional requirements of ANSI B18.22.2. Type A Plain |
| Expansion wedge (clip) | Carbon Steel |
| Plating | Zinc plating according to ASTM B 633, SC1 Type III (Fe/Zn 5). Minimum plating requirements for Mild Service Condition. |

SECTION CONTENTS

General Information..... 1
 Material Specifications 1
 Installation Instructions 2
 Reference Data (ASD)..... 3
 Strength Design (SD)..... 9
 Strength Design Performance Data 13
 Ordering Information..... 14



POWER-STUD+ SD1 ASSEMBLY

THREAD VERSION

- UNC threaded stud

ANCHOR MATERIALS

- Zinc plated carbon steel body with expansion clip, nut and washer

ANCHOR SIZE RANGE (TYP.)

- 1/4" diameter through 1-1/4" diameter

SUITABLE BASE MATERIALS

- Normal-weight concrete
- Sand-lightweight concrete
- Concrete over steel deck
- Grouted concrete masonry (CMU)



INSTALLATION INSTRUCTIONS

Installation Instructions for Power-Stud+ SD1

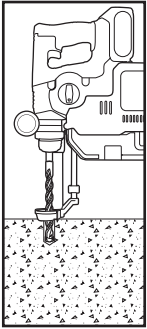

Step 1
Using the proper drill bit size, drill a hole into the base material to the required depth. The tolerances of the drill bit used should meet the requirements of ANSI Standard B212.15.

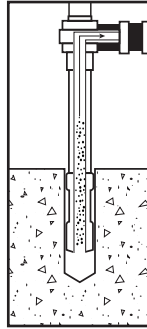

Step 2
Remove the dust and debris from the hole during drilling (e.g. dust extractor, hollow bit) or following drilling (e.g. suction, forced air) to extract loose particles created by drilling.

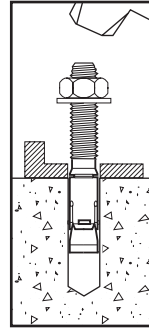

Step 3
Position the washer on the anchor and thread on the nut. If installing through a fixture, drive the anchor through the fixture into the hole. Be sure the anchor is driven to the minimum required embedment depth, h_{nom} .

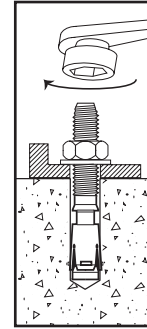

Step 4
Tighten the anchor with a torque wrench by applying the required installation torque, T_{inst} . Note: The threaded stud will draw up during tightening of the nut; the expansion wedge (clip) remains in original position.

Installation Instructions for Power-Stud+ SD1 Tie Wire Version

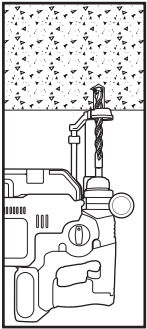

Step 1
Using the proper drill bit size, drill a hole into the base material to the required depth. The tolerances of the drill bit used should meet the requirements of ANSI Standard B212.15.

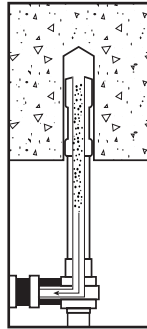

Step 2
Remove the dust and debris from the hole during drilling (e.g. dust extractor) or following drilling (e.g. suction, forced air) to extract loose particles created by drilling.

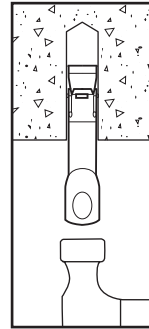

Step 3
Drive the anchor into the hole until the head is firmly seated against the base material. Be sure the anchor is driven to the required embedment depth.

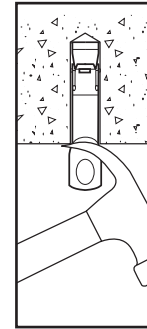

Step 4
Set the anchor with a prying action using a claw hammer.

Power-Stud+ SD1 Anchor Detail

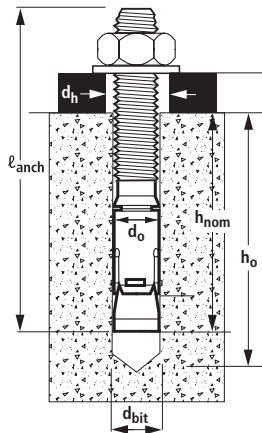

Power-Stud+ SD1 Anchor Assembly

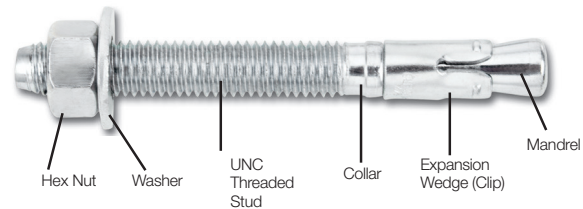

Head Marking



Legend

- Letter Code = Length Identification Mark
- '+' Symbol = Strength Design Compliant Anchor (see ordering information)
- Number Code 1 = Carbon Steel Body and Carbon Steel Expansion Clip (not on 1/4" diameter anchors)

Length Identification

| Mark | A | B | C | D | E | F | G | H | I | J | K | L | M | N | O | P | Q | R | S | T |
|-------------------------|--------|--------|--------|--------|--------|--------|--------|--------|--------|--------|--------|--------|--------|--------|--------|--------|--------|-----|-----|-----|
| From | 1-1/2" | 2" | 2-1/2" | 3" | 3-1/2" | 4" | 4-1/2" | 5" | 5-1/2" | 6" | 6-1/2" | 7" | 7-1/2" | 8" | 8-1/2" | 9" | 9-1/2" | 10" | 11" | 12" |
| Up to but not including | 2" | 2-1/2" | 3" | 3-1/2" | 4" | 4-1/2" | 5" | 5-1/2" | 6" | 6-1/2" | 7" | 7-1/2" | 8" | 8-1/2" | 9" | 9-1/2" | 10" | 11" | 12" | 13" |

Length identification mark indicates overall length of anchor.

REFERENCE DATA (ASD)

Installation Specifications for Power-Stud+ SD1 in Concrete^{1,2}

| Anchor Property/ Setting Information | Notation | Units | Nominal Anchor Diameter | | | | | | | |
|--|------------|-------------------|-------------------------|----------------|-----------------|-----------------|-----------------|-----------------|-----------------|-----------------|
| | | | 1/4 | 3/8 | 1/2 | 5/8 | 3/4 | 7/8 | 1 | 1-1/4 |
| Anchor diameter | d_o | in. (mm) | 0.250 (6.4) | 0.375 (9.5) | 0.500 (12.7) | 0.625 (15.9) | 0.750 (19.1) | 0.875 (22.2) | 1.000 (25.4) | 1.250 (31.8) |
| Minimum diameter of hole clearance in fixture | d_h | in. (mm) | 5/16 (7.5) | 7/16 (11.1) | 9/16 (14.3) | 11/16 (17.5) | 13/16 (20.6) | 1 (25.4) | 1-1/8 (28.6) | 1-3/8 (34.9) |
| Nominal drill bit diameter | d_{bit} | in. ANSI | 1/4" ANSI | 3/8" ANSI | 1/2" ANSI | 5/8" ANSI | 3/4" ANSI | 7/8" ANSI | 1" ANSI | 1-1/4" ANSI |
| Minimum nominal embedment depth | h_{nom} | in. (mm) | 1-1/8 (29) | 1-5/8 (41) | 2-1/4 (57) | 2-3/4 (70) | 3-3/8 (86) | 4-1/2 (114) | 4-1/2 (114) | 6-1/2 (165) |
| Minimum hole depth | h_o | in. (mm) | 1-1/4 (48) | 1-3/4 (44) | 2-1/2 (64) | 3-1/8 (79) | 3-5/8 (92) | 4-7/8 (122) | 4-7/8 (122) | 7-1/4 (184) |
| Installation torque | T_{inst} | ft.-lbf. (N-m) | 4 (5) | 20 (27) | 40 (54) | 80 (108) | 110 (149) | 175 (237) | 225 (305) | 375 (508) |
| Torque wrench/ socket size | - | in. | 7/16 | 9/16 | 3/4 | 15/16 | 1-1/8 | 1-5/16 | 1-1/2 | 1-7/8 |
| Nut height | - | In. | 7/32 | 21/64 | 7/16 | 35/64 | 41/64 | 3/4 | 55/64 | 1-1/16 |

For SI: 1 inch = 25.4 mm, 1 ft-lbf = 1.356 N-m.

- The minimum base material thickness should be $1.5h_{nom}$ or 3", whichever is greater.
- See Performance Data in Concrete for additional embedment depths.

Ultimate Load Capacities for Power-Stud+ SD1 in Normal-Weight Concrete^{1,2}

| Nominal Anchor Diameter in. | Minimum Embedment Depth in. (mm) | Minimum Concrete Compressive Strength | | | | | | | |
|--------------------------------------|--|---------------------------------------|-----------------------|---------------------------------------|-----------------------|---------------------------------------|-----------------------|---------------------------------------|-----------------------|
| | | $f'_c = 2,500 \text{ psi (17.3 MPa)}$ | | $f'_c = 3,000 \text{ psi (20.7 MPa)}$ | | $f'_c = 4,000 \text{ psi (27.6 MPa)}$ | | $f'_c = 6,000 \text{ psi (41.4 MPa)}$ | |
| | | Tension lbs. (kN) | Shear lbs. (kN) | Tension lbs. (kN) | Shear lbs. (kN) | Tension lbs. (kN) | Shear lbs. (kN) | Tension lbs. (kN) | Shear lbs. (kN) |
| 1/4 | 1-1/8 (28) | 1,320 (5.9) | 1,160 (5.2) | 1,435 (6.4) | 1,255 (5.6) | 1,660 (7.4) | 1,255 (5.6) | - | - |
| | 1-3/4 (44) | 2,775 (12.4) | 1,255 (5.6) | 2,775 (12.4) | 1,255 (5.6) | 2,775 (12.4) | 1,255 (5.6) | 2,775 (12.4) | 1,255 (5.6) |
| 3/8 | 1-5/8 (41) | 2,240 (10.9) | 2,320 (10.3) | 2,685 (12) | 2,540 (11.3) | 3,100 (13.8) | 2,540 (11.3) | - | - |
| | 2-3/8 (60) | 3,485 (15.5) | 2,540 (11.3) | 3,815 (17) | 2,540 (11.3) | 4,410 (19.6) | 2,540 (11.3) | 5,400 (24) | 2,540 (11.3) |
| 1/2 | 2-1/4 (57) | 3,800 (16.9) | 3,840 (17.1) | 4,155 (18.5) | 4,195 (18.7) | 4,800 (21.4) | 4,195 (18.7) | - | - |
| | 2-1/2 (64) | 3,910 (17.4) | 4,195 (18.7) | 4,285 (19.1) | 4,195 (18.7) | 4,950 (22) | 4,195 (18.7) | 6,060 (27) | 4,195 (18.7) |
| | 3-3/4 (95) | 7,955 (35.4) | 4,195 (18.7) | 8,715 (38.8) | 4,195 (18.7) | 10,065 (44.8) | 4,195 (18.7) | 12,325 (54.8) | 4,195 (18.7) |
| 5/8 | 2-3/4 (70) | 4,960 (22.1) | 6,220 (27.7) | 5,440 (24.3) | 6,815 (30.3) | 6,285 (28) | 6,815 (30.3) | - | - |
| | 3-3/8 (86) | 6,625 (29.5) | 6,815 (30.3) | 7,260 (32.3) | 6,815 (30.3) | 8,380 (37.3) | 6,815 (30.3) | 10,265 (45.7) | 6,815 (30.3) |
| | 4-5/8 (117) | 11,260 (50.1) | 6,815 (30.3) | 12,335 (54.9) | 6,815 (30.3) | 14,245 (63.4) | 6,815 (30.3) | 14,465 (65.7) | 6,815 (30.3) |
| 3/4 | 3-3/8 (86) | 7,180 (31.9) | 11,480 (51.5) | 7,860 (32.2) | 12,580 (56.0) | 9,075 (40.5) | 12,580 (56.0) | - | - |
| | 4 (102) | 9,530 (42.4) | 12,580 (56.0) | 10,440 (46.5) | 12,580 (56.0) | 12,060 (53.6) | 12,580 (56.0) | 14,770 (65.7) | 12,580 (56.0) |
| | 5-5/8 (143) | 17,670 (78.6) | 12,580 (56.0) | 19,355 (86.1) | 12,580 (56.0) | 22,350 (99.4) | 12,580 (56.0) | 25,065 (111.5) | 12,580 (56.0) |
| 7/8 | 3-7/8 (98) | 9,120 (40.6) | 10,680 (47.5) | 10,005 (44.5) | 11,690 (52.0) | 11,555 (51.4) | 11,690 (52.0) | - | - |
| | 4-1/2 (114) | 11,320 (50.4) | 11,690 (52.0) | 12,405 (55.2) | 11,690 (52.0) | 15,125 (67.3) | 11,690 (52.0) | 19,470 (86.6) | 11,690 (52.0) |
| 1 | 4-1/2 (114) | 12,400 (55.2) | 19,320 (85.9) | 13,580 (60.4) | 21,155 (94.1) | 15,680 (69.7) | 21,155 (94.1) | - | - |
| | 5-1/2 (140) | 16,535 (73.6) | 21,155 (94.1) | 18,115 (80.6) | 21,155 (94.1) | 20,915 (93) | 21,155 (94.1) | 25,615 (114) | 21,155 (94.1) |
| | 8 (203) | 19,640 (87.4) | 21,155 (94.1) | 21,530 (95.8) | 21,155 (94.1) | 24,865 (110.6) | 21,155 (94.1) | - | - |
| 1-1/4 | 5-1/2 (140) | 18,520 (82.5) | 26,560 (118.1) | 20,275 (90.9) | 29,105 (129.4) | 23,410 (105.0) | 29,105 (129.4) | - | - |
| | 6-1/2 (165) | 22,485 (100.0) | 29,105 (129.4) | 24,630 (109.6) | 29,105 (129.4) | 28,440 (126.5) | 29,105 (129.4) | 37,360 (166.2) | 29,105 (129.4) |

- Tabulated load values are for anchors installed in uncracked concrete with no edge or spacing considerations. Concrete compressive strength must be at the specified minimum at the time of installation.
- Ultimate load capacities must be reduced by a minimum safety factor of 4.0 or greater to determine allowable working loads.



Allowable Load Capacities for Power-Stud+ SD1 in Normal-Weight Concrete^{1,2,3,4}

| Nominal Anchor Diameter (in.) | Minimum Embedment Depth in. (mm) | Minimum Concrete Compressive Strength | | | | | | | |
|-------------------------------|----------------------------------|---------------------------------------|-----------------|----------------------------|-----------------|----------------------------|-----------------|----------------------------|-----------------|
| | | f'c = 2,500 psi (17.3 MPa) | | f'c = 3,000 psi (20.7 MPa) | | f'c = 4,000 psi (27.6 MPa) | | f'c = 6,000 psi (41.4 MPa) | |
| | | Tension lbs. (kN) | Shear lbs. (kN) | Tension lbs. (kN) | Shear lbs. (kN) | Tension lbs. (kN) | Shear lbs. (kN) | Tension lbs. (kN) | Shear lbs. (kN) |
| 1/4 | 1-1/8 (28) | 330 (1.5) | 290 (1.3) | 360 (1.6) | 315 (1.4) | 415 (1.8) | 315 (1.4) | - | - |
| | 1-3/4 (44) | 695 (3.1) | 315 (1.4) | 695 (3.1) | 315 (1.4) | 695 (3.1) | 315 (1.4) | 695 (3.1) | 315 (1.4) |
| 3/8 | 1-5/8 (41) | 610 (2.7) | 580 (2.6) | 670 (3.0) | 635 (2.8) | 775 (3.4) | 635 (2.8) | - | - |
| | 2-3/8 (60) | 870 (3.9) | 635 (2.8) | 955 (4.2) | 635 (2.8) | 1,105 (4.9) | 635 (2.8) | 1,350 (6.0) | 635 (2.8) |
| 1/2 | 2-1/4 (57) | 950 (4.2) | 960 (4.3) | 1,040 (4.6) | 1,050 (4.7) | 1,200 (5.3) | 1,050 (4.7) | - | - |
| | 2-1/2 (64) | 980 (4.4) | 1,050 (4.7) | 1,070 (4.8) | 1,050 (4.7) | 1,240 (5.5) | 1,050 (4.7) | 1,515 (6.7) | 1,050 (4.7) |
| | 3-3/4 (95) | 1,990 (8.9) | 1,050 (4.7) | 2,180 (9.7) | 1,050 (4.7) | 2,515 (11.2) | 1,050 (4.7) | 3,080 (13.7) | 1,050 (4.7) |
| 5/8 | 2-3/4 (70) | 1,240 (5.5) | 1,555 (6.9) | 1,360 (6.0) | 1,705 (7.6) | 1,570 (7.0) | 1,705 (7.6) | - | - |
| | 3-3/8 (86) | 1,655 (7.4) | 1,705 (7.6) | 1,815 (8.1) | 1,705 (7.6) | 2,095 (9.3) | 1,705 (7.6) | 2,565 (11.4) | 1,705 (7.6) |
| | 4-5/8 (117) | 2,815 (12.5) | 1,705 (7.6) | 3,085 (13.7) | 1,705 (7.6) | 3,560 (15.8) | 1,705 (7.6) | 3,615 (16.1) | 1,705 (7.6) |
| 3/4 | 3-3/8 (86) | 1,795 (8.0) | 2,870 (12.8) | 1,965 (8.7) | 3,145 (14.0) | 2,270 (10.1) | 3,145 (14.0) | - | - |
| | 4 (102) | 2,385 (10.6) | 3,145 (14.0) | 2,610 (11.6) | 3,145 (14.0) | 3,015 (13.4) | 3,145 (14.0) | 3,620 (16.1) | 3,145 (14.0) |
| | 5-5/8 (143) | 4,420 (19.7) | 3,145 (14.0) | 4,840 (21.5) | 3,145 (14.0) | 5,590 (24.9) | 3,145 (14.0) | 6,265 (27.9) | 3,145 (14.0) |
| 7/8 | 3-7/8 (98) | 2,280 (10.1) | 2,670 (11.9) | 2,500 (11.1) | 2,925 (13.0) | 2,890 (12.9) | 2,925 (13.0) | - | - |
| | 4-1/2 (114) | 2,830 (12.6) | 2,925 (13.0) | 3,100 (13.8) | 2,925 (13.0) | 3,780 (16.8) | 2,925 (13.0) | 4,870 (21.7) | 2,925 (13.0) |
| 1 | 4-1/2 (114) | 3,100 (13.8) | 4,830 (21.5) | 3,395 (15.1) | 5,290 (23.5) | 3,920 (17.4) | 5,290 (23.5) | - | - |
| | 5-1/2 (140) | 4,135 (18.4) | 5,290 (23.5) | 4,530 (20.2) | 5,290 (23.5) | 5,230 (23.3) | 5,290 (23.5) | 6,405 (28.5) | 5,290 (23.5) |
| | 8 (203) | 4,910 (21.8) | 5,290 (23.5) | 5,380 (23.9) | 5,290 (23.5) | 6,215 (27.6) | 5,290 (23.5) | - | - |
| 1-1/4 | 5-1/2 (140) | 4,630 (20.6) | 6,640 (29.5) | 5,070 (22.6) | 7,275 (32.4) | 5,850 (26.0) | 7,275 (32.4) | - | - |
| | 6-1/2 (165) | 5,620 (25.0) | 7,275 (32.4) | 6,160 (27.4) | 7,275 (32.4) | 7,110 (31.6) | 7,275 (32.4) | 9,340 (41.5) | 7,275 (32.4) |

1. Tabulated load values are for anchors installed in concrete. Concrete compressive strength must be at the minimum at the time of installation.
2. Allowable load capacities are calculated using an applied safety factor of 4.0.
3. Allowable load capacities must be multiplied by reduction factors when anchor spacing or edge distances are less than critical distances.
4. Linear interpolation may be used to determine allowable loads for intermediate embedments and compressive strengths.

MECHANICAL ANCHORS

POWER-STUD® + SD1
Wedge Expansion Anchor

Spacing Distance and Edge Distance Tension (F_{NSy} , F_{NC}) Adjustment Factors for Normal-Weight Concrete

| Di. (in.) | 1/4 | 3/8 | 1/2 | 1/2 | 5/8 | 5/8 | 3/4 | 3/4 | 7/8 | 1 | 1-1/4 |
|---------------------------|-------|-------|-------|-------|-------|-------|------|-------|-------|-------|-------|
| h_{nom} (in.) | 1-3/4 | 2-3/8 | 2-1/2 | 3-3/4 | 3-3/8 | 4-5/8 | 4 | 5-5/8 | 4-1/2 | 5-1/2 | 6-1/2 |
| s_{min} (in.) | 2-1/4 | 3-1/2 | 4-1/2 | 5 | 6 | 4-1/4 | 6 | 6-1/2 | 6-1/2 | 8 | 8 |
| Spacing Distance (inches) | 2 | - | - | - | - | - | - | - | - | - | - |
| | 2-1/4 | 0.78 | - | - | - | - | - | - | - | - | - |
| | 2-1/2 | 0.80 | - | - | - | - | - | - | - | - | - |
| | 2-3/4 | 0.83 | - | - | - | - | - | - | - | - | - |
| | 3 | 0.85 | - | - | - | - | - | - | - | - | - |
| | 3-1/2 | 0.90 | 0.84 | - | - | - | - | - | - | - | - |
| | 4 | 0.95 | 0.87 | - | - | - | - | - | - | - | - |
| | 4-1/4 | 0.98 | 0.89 | - | - | - | 0.72 | - | - | - | - |
| | 4-1/2 | 1.00 | 0.90 | 0.91 | - | - | 0.73 | - | - | - | - |
| | 5 | 1.00 | 0.94 | 0.94 | 0.79 | - | 0.75 | - | - | - | - |
| | 5-1/2 | 1.00 | 0.97 | 0.97 | 0.81 | - | 0.77 | - | - | - | - |
| | 6 | 1.00 | 1.00 | 1.00 | 0.83 | 0.88 | 0.79 | 0.87 | - | - | - |
| | 6-1/2 | 1.00 | 1.00 | 1.00 | 0.86 | 0.90 | 0.80 | 0.89 | 0.79 | 0.85 | - |
| | 7 | 1.00 | 1.00 | 1.00 | 0.88 | 0.93 | 0.82 | 0.91 | 0.81 | 0.87 | - |
| | 7-1/2 | 1.00 | 1.00 | 1.00 | 0.90 | 0.96 | 0.84 | 0.93 | 0.82 | 0.89 | - |
| | 8 | 1.00 | 1.00 | 1.00 | 0.92 | 0.99 | 0.86 | 0.95 | 0.83 | 0.91 | 0.84 |
| | 8-1/2 | 1.00 | 1.00 | 1.00 | 0.94 | 1.00 | 0.88 | 0.97 | 0.85 | 0.93 | 0.85 |
| 9 | 1.00 | 1.00 | 1.00 | 0.97 | 1.00 | 0.89 | 0.99 | 0.86 | 0.94 | 0.87 | |
| 9-1/2 | 1.00 | 1.00 | 1.00 | 0.99 | 1.00 | 0.91 | 1.00 | 0.87 | 0.96 | 0.89 | |
| 10 | 1.00 | 1.00 | 1.00 | 1.00 | 1.00 | 0.93 | 1.00 | 0.89 | 0.98 | 0.90 | |
| 10-1/2 | 1.00 | 1.00 | 1.00 | 1.00 | 1.00 | 0.95 | 1.00 | 0.90 | 1.00 | 0.92 | |
| 11 | 1.00 | 1.00 | 1.00 | 1.00 | 1.00 | 0.96 | 1.00 | 0.91 | 1.00 | 0.93 | |
| 11-1/2 | 1.00 | 1.00 | 1.00 | 1.00 | 1.00 | 0.98 | 1.00 | 0.93 | 1.00 | 0.95 | |
| 12 | 1.00 | 1.00 | 1.00 | 1.00 | 1.00 | 1.00 | 1.00 | 0.94 | 1.00 | 0.96 | |
| 12-1/2 | 1.00 | 1.00 | 1.00 | 1.00 | 1.00 | 1.00 | 1.00 | 0.95 | 1.00 | 0.98 | |
| 13 | 1.00 | 1.00 | 1.00 | 1.00 | 1.00 | 1.00 | 1.00 | 0.97 | 1.00 | 1.00 | |
| 13-1/2 | 1.00 | 1.00 | 1.00 | 1.00 | 1.00 | 1.00 | 1.00 | 0.98 | 1.00 | 1.00 | |
| 14 | 1.00 | 1.00 | 1.00 | 1.00 | 1.00 | 1.00 | 1.00 | 0.99 | 1.00 | 1.00 | |
| 14-1/2 | 1.00 | 1.00 | 1.00 | 1.00 | 1.00 | 1.00 | 1.00 | 1.00 | 1.00 | 1.00 | |
| 15 | 1.00 | 1.00 | 1.00 | 1.00 | 1.00 | 1.00 | 1.00 | 1.00 | 1.00 | 1.00 | |
| 15-1/2 | 1.00 | 1.00 | 1.00 | 1.00 | 1.00 | 1.00 | 1.00 | 1.00 | 1.00 | 1.00 | |
| 16 | 1.00 | 1.00 | 1.00 | 1.00 | 1.00 | 1.00 | 1.00 | 1.00 | 1.00 | 1.00 | |

| Di. (in.) | 1/4 | 3/8 | 1/2 | 1/2 | 5/8 | 5/8 | 3/4 | 3/4 | 7/8 | 1 | 1-1/4 |
|------------------------|-------|-------|-------|-------|-------|-------|------|-------|--------|-------|-------|
| h_{nom} (in.) | 1-3/4 | 2-3/8 | 2-1/2 | 3-3/4 | 3-3/8 | 4-5/8 | 4 | 5-5/8 | 4-1/2 | 5-1/2 | 6-1/2 |
| c_{ac} (in.) | 3-1/2 | 6-1/2 | 8 | 8 | 6 | 10 | 11 | 16 | 11-1/2 | 12 | 20 |
| c_{min} (in.) | 1-3/4 | 2-1/4 | 3-1/4 | 2-3/4 | 5-1/2 | 4-1/4 | 5 | 6 | 7 | 8 | 8 |
| Edge Distance (inches) | 1-3/4 | 0.50 | - | - | - | - | - | - | - | - | - |
| | 2 | 0.57 | - | - | - | - | - | - | - | - | - |
| | 2-1/4 | 0.64 | 0.35 | - | - | - | - | - | - | - | - |
| | 2-1/2 | 0.71 | 0.38 | - | - | - | - | - | - | - | - |
| | 2-3/4 | 0.79 | 0.42 | - | 0.34 | - | - | - | - | - | - |
| | 3 | 0.86 | 0.46 | - | 0.38 | - | - | - | - | - | - |
| | 3-1/4 | 0.93 | 0.50 | 0.41 | 0.41 | - | - | - | - | - | - |
| | 3-1/2 | 1.00 | 0.54 | 0.44 | 0.44 | - | - | - | - | - | - |
| | 4 | 1.00 | 0.62 | 0.50 | 0.50 | - | - | - | - | - | - |
| | 4-1/4 | 1.00 | 0.65 | 0.53 | 0.53 | - | 0.43 | - | - | - | - |
| | 4-1/2 | 1.00 | 0.69 | 0.56 | 0.56 | - | 0.45 | - | - | - | - |
| | 5 | 1.00 | 0.77 | 0.63 | 0.63 | - | 0.50 | 0.45 | - | - | - |
| | 5-1/2 | 1.00 | 0.85 | 0.69 | 0.69 | 0.92 | 0.55 | 0.50 | - | - | - |
| | 6 | 1.00 | 0.92 | 0.75 | 0.75 | 1.00 | 0.60 | 0.55 | 0.38 | - | - |
| | 6-1/2 | 1.00 | 1.00 | 0.81 | 0.81 | 1.00 | 0.65 | 0.59 | 0.41 | - | - |
| | 7 | 1.00 | 1.00 | 0.88 | 0.88 | 1.00 | 0.70 | 0.64 | 0.44 | 0.61 | - |
| | 7-1/2 | 1.00 | 1.00 | 0.94 | 0.94 | 1.00 | 0.75 | 0.68 | 0.47 | 0.65 | - |
| | 8 | 1.00 | 1.00 | 1.00 | 1.00 | 1.00 | 0.80 | 0.73 | 0.50 | 0.70 | 0.67 |
| | 8-1/2 | 1.00 | 1.00 | 1.00 | 1.00 | 1.00 | 0.85 | 0.77 | 0.53 | 0.74 | 0.71 |
| | 9 | 1.00 | 1.00 | 1.00 | 1.00 | 1.00 | 0.90 | 0.82 | 0.56 | 0.78 | 0.75 |
| 9-1/2 | 1.00 | 1.00 | 1.00 | 1.00 | 1.00 | 0.95 | 0.86 | 0.59 | 0.83 | 0.79 | |
| 10 | 1.00 | 1.00 | 1.00 | 1.00 | 1.00 | 1.00 | 0.91 | 0.63 | 0.87 | 0.83 | |
| 10-1/2 | 1.00 | 1.00 | 1.00 | 1.00 | 1.00 | 1.00 | 0.95 | 0.66 | 0.91 | 0.88 | |
| 11 | 1.00 | 1.00 | 1.00 | 1.00 | 1.00 | 1.00 | 1.00 | 0.69 | 0.96 | 0.92 | |
| 11-1/2 | 1.00 | 1.00 | 1.00 | 1.00 | 1.00 | 1.00 | 1.00 | 0.72 | 1.00 | 0.96 | |
| 12 | 1.00 | 1.00 | 1.00 | 1.00 | 1.00 | 1.00 | 1.00 | 0.75 | 1.00 | 1.00 | |
| 12-1/2 | 1.00 | 1.00 | 1.00 | 1.00 | 1.00 | 1.00 | 1.00 | 0.78 | 1.00 | 1.00 | |
| 13 | 1.00 | 1.00 | 1.00 | 1.00 | 1.00 | 1.00 | 1.00 | 0.81 | 1.00 | 1.00 | |
| 13-1/2 | 1.00 | 1.00 | 1.00 | 1.00 | 1.00 | 1.00 | 1.00 | 0.84 | 1.00 | 1.00 | |
| 14 | 1.00 | 1.00 | 1.00 | 1.00 | 1.00 | 1.00 | 1.00 | 0.88 | 1.00 | 1.00 | |
| 14-1/2 | 1.00 | 1.00 | 1.00 | 1.00 | 1.00 | 1.00 | 1.00 | 0.91 | 1.00 | 1.00 | |
| 15 | 1.00 | 1.00 | 1.00 | 1.00 | 1.00 | 1.00 | 1.00 | 0.94 | 1.00 | 1.00 | |
| 15-1/2 | 1.00 | 1.00 | 1.00 | 1.00 | 1.00 | 1.00 | 1.00 | 0.97 | 1.00 | 1.00 | |
| 16 | 1.00 | 1.00 | 1.00 | 1.00 | 1.00 | 1.00 | 1.00 | 1.00 | 1.00 | 1.00 | |
| 16-1/2 | 1.00 | 1.00 | 1.00 | 1.00 | 1.00 | 1.00 | 1.00 | 1.00 | 1.00 | 1.00 | |
| 17 | 1.00 | 1.00 | 1.00 | 1.00 | 1.00 | 1.00 | 1.00 | 1.00 | 1.00 | 1.00 | |
| 17-1/2 | 1.00 | 1.00 | 1.00 | 1.00 | 1.00 | 1.00 | 1.00 | 1.00 | 1.00 | 1.00 | |
| 18 | 1.00 | 1.00 | 1.00 | 1.00 | 1.00 | 1.00 | 1.00 | 1.00 | 1.00 | 1.00 | |
| 18-1/2 | 1.00 | 1.00 | 1.00 | 1.00 | 1.00 | 1.00 | 1.00 | 1.00 | 1.00 | 1.00 | |
| 19 | 1.00 | 1.00 | 1.00 | 1.00 | 1.00 | 1.00 | 1.00 | 1.00 | 1.00 | 1.00 | |
| 19-1/2 | 1.00 | 1.00 | 1.00 | 1.00 | 1.00 | 1.00 | 1.00 | 1.00 | 1.00 | 1.00 | |
| 20 | 1.00 | 1.00 | 1.00 | 1.00 | 1.00 | 1.00 | 1.00 | 1.00 | 1.00 | 1.00 | |

MECHANICAL ANCHORS

POWER-STUD® + SD1

Wedge Expansion Anchor

Spacing Distance and Edge Distance Shear (F_{VS} , F_{VC}) Adjustment Factors for Normal-Weight Concrete

| Spacing Distance (inches) | Dia. (in) | 1/4 | 3/8 | 1/2 | 1/2 | 5/8 | 5/8 | 3/4 | 3/4 | 7/8 | 1 | 1-1/4 |
|---------------------------|-----------------|-------|-------|-------|-------|-------|-------|------|-------|-------|-------|-------|
| | h_{nom} (in.) | 1-3/4 | 2-3/8 | 2-1/2 | 3-3/4 | 3-3/8 | 4-5/8 | 4 | 5-5/8 | 4-1/2 | 5-1/2 | 6-1/2 |
| | s_{min} (in.) | 2-1/4 | 3-1/2 | 4-1/2 | 5 | 6 | 4-1/4 | 6 | 6-1/2 | 6-1/2 | 8 | 8 |
| 2-1/4 | 0.85 | - | - | - | - | - | - | - | - | - | - | - |
| 2-1/2 | 0.87 | - | - | - | - | - | - | - | - | - | - | - |
| 2-3/4 | 0.88 | - | - | - | - | - | - | - | - | - | - | - |
| 3 | 0.90 | - | - | - | - | - | - | - | - | - | - | - |
| 3-1/2 | 0.93 | 0.90 | - | - | - | - | - | - | - | - | - | - |
| 4 | 0.97 | 0.92 | - | - | - | - | - | - | - | - | - | - |
| 4-1/4 | 0.98 | 0.93 | - | - | - | 0.82 | - | - | - | - | - | - |
| 4-1/2 | 1.00 | 0.94 | 0.95 | - | - | 0.82 | - | - | - | - | - | - |
| 5 | 1.00 | 0.96 | 0.97 | 0.86 | - | 0.83 | - | - | - | - | - | - |
| 5-1/2 | 1.00 | 0.98 | 0.98 | 0.87 | - | 0.85 | - | - | - | - | - | - |
| 6 | 1.00 | 1.00 | 1.00 | 0.89 | 0.91 | 0.86 | 0.92 | - | - | - | - | - |
| 6-1/2 | 1.00 | 1.00 | 1.00 | 0.90 | 0.93 | 0.87 | 0.93 | 0.88 | 0.91 | - | - | - |
| 7 | 1.00 | 1.00 | 1.00 | 0.92 | 0.95 | 0.88 | 0.94 | 0.88 | 0.92 | - | - | - |
| 7-1/2 | 1.00 | 1.00 | 1.00 | 0.93 | 0.97 | 0.89 | 0.96 | 0.89 | 0.93 | - | - | - |
| 8 | 1.00 | 1.00 | 1.00 | 0.95 | 0.99 | 0.90 | 0.97 | 0.90 | 0.94 | 0.90 | 0.89 | - |
| 8-1/2 | 1.00 | 1.00 | 1.00 | 0.96 | 1.00 | 0.92 | 0.98 | 0.91 | 0.96 | 0.91 | 0.90 | - |
| 9 | 1.00 | 1.00 | 1.00 | 0.98 | 1.00 | 0.93 | 0.99 | 0.92 | 0.97 | 0.92 | 0.91 | - |
| 9-1/2 | 1.00 | 1.00 | 1.00 | 0.99 | 1.00 | 0.94 | 1.00 | 0.92 | 0.98 | 0.93 | 0.91 | - |
| 10 | 1.00 | 1.00 | 1.00 | 1.00 | 1.00 | 0.95 | 1.00 | 0.93 | 0.99 | 0.94 | 0.92 | - |
| 10-1/2 | 1.00 | 1.00 | 1.00 | 1.00 | 1.00 | 0.96 | 1.00 | 0.94 | 1.00 | 0.95 | 0.93 | - |
| 11 | 1.00 | 1.00 | 1.00 | 1.00 | 1.00 | 0.98 | 1.00 | 0.95 | 1.00 | 0.96 | 0.93 | - |
| 11-1/2 | 1.00 | 1.00 | 1.00 | 1.00 | 1.00 | 0.99 | 1.00 | 0.96 | 1.00 | 0.97 | 0.94 | - |
| 12 | 1.00 | 1.00 | 1.00 | 1.00 | 1.00 | 1.00 | 1.00 | 0.96 | 1.00 | 0.98 | 0.95 | - |
| 12-1/2 | 1.00 | 1.00 | 1.00 | 1.00 | 1.00 | 1.00 | 1.00 | 0.97 | 1.00 | 0.99 | 0.95 | - |
| 13 | 1.00 | 1.00 | 1.00 | 1.00 | 1.00 | 1.00 | 1.00 | 0.98 | 1.00 | 1.00 | 0.96 | - |
| 13-1/2 | 1.00 | 1.00 | 1.00 | 1.00 | 1.00 | 1.00 | 1.00 | 0.99 | 1.00 | 1.00 | 0.97 | - |
| 14 | 1.00 | 1.00 | 1.00 | 1.00 | 1.00 | 1.00 | 1.00 | 1.00 | 1.00 | 1.00 | 0.97 | - |
| 14-1/2 | 1.00 | 1.00 | 1.00 | 1.00 | 1.00 | 1.00 | 1.00 | 1.00 | 1.00 | 1.00 | 0.98 | - |
| 15 | 1.00 | 1.00 | 1.00 | 1.00 | 1.00 | 1.00 | 1.00 | 1.00 | 1.00 | 1.00 | 0.99 | - |
| 15-1/2 | 1.00 | 1.00 | 1.00 | 1.00 | 1.00 | 1.00 | 1.00 | 1.00 | 1.00 | 1.00 | 0.99 | - |
| 16 | 1.00 | 1.00 | 1.00 | 1.00 | 1.00 | 1.00 | 1.00 | 1.00 | 1.00 | 1.00 | 1.00 | - |

| Edge Distance (inches) | Dia. (in) | 1/4 | 3/8 | 1/2 | 1/2 | 5/8 | 5/8 | 3/4 | 3/4 | 7/8 | 1 | 1-1/4 |
|------------------------|-----------------|-------|-------|-------|-------|-------|-------|------|-------|-------|-------|-------|
| | h_{nom} (in.) | 1-3/4 | 2-3/8 | 2-1/2 | 3-3/4 | 3-3/8 | 4-5/8 | 4 | 5-5/8 | 4-1/2 | 5-1/2 | 6-1/2 |
| | c_{min} (in.) | 1-3/4 | 2-1/4 | 3-1/4 | 2-3/4 | 5-1/2 | 4-1/4 | 5 | 6 | 7 | 8 | 8 |
| 1-3/4 | 0.39 | - | - | - | - | - | - | - | - | - | - | - |
| 2 | 0.44 | - | - | - | - | - | - | - | - | - | - | - |
| 2-1/4 | 0.50 | 0.38 | - | - | - | - | - | - | - | - | - | - |
| 2-1/2 | 0.56 | 0.42 | - | - | - | - | - | - | - | - | - | - |
| 2-3/4 | 0.61 | 0.46 | - | 0.28 | - | - | - | - | - | - | - | - |
| 3 | 0.67 | 0.50 | - | 0.31 | - | - | - | - | - | - | - | - |
| 3-1/4 | 0.72 | 0.54 | 0.54 | 0.33 | - | - | - | - | - | - | - | - |
| 3-1/2 | 0.78 | 0.58 | 0.58 | 0.36 | - | - | - | - | - | - | - | - |
| 4 | 0.89 | 0.67 | 0.67 | 0.41 | - | - | - | - | - | - | - | - |
| 4-1/4 | 0.94 | 0.71 | 0.71 | 0.44 | - | 0.35 | - | - | - | - | - | - |
| 4-1/2 | 1.00 | 0.75 | 0.75 | 0.46 | - | 0.38 | - | - | - | - | - | - |
| 5 | 1.00 | 0.83 | 0.83 | 0.51 | - | 0.42 | 0.53 | - | - | - | - | - |
| 5-1/2 | 1.00 | 0.92 | 0.92 | 0.56 | 0.67 | 0.46 | 0.59 | - | - | - | - | - |
| 6 | 1.00 | 1.00 | 1.00 | 0.62 | 0.73 | 0.50 | 0.64 | 0.42 | - | - | - | - |
| 6-1/2 | 1.00 | 1.00 | 1.00 | 0.67 | 0.79 | 0.54 | 0.69 | 0.46 | - | - | - | - |
| 7 | 1.00 | 1.00 | 1.00 | 0.72 | 0.85 | 0.58 | 0.75 | 0.49 | 0.67 | - | - | - |
| 7-1/2 | 1.00 | 1.00 | 1.00 | 0.77 | 0.91 | 0.63 | 0.80 | 0.53 | 0.71 | - | - | - |
| 8 | 1.00 | 1.00 | 1.00 | 0.82 | 0.97 | 0.67 | 0.85 | 0.56 | 0.76 | 0.61 | 0.50 | - |
| 8-1/2 | 1.00 | 1.00 | 1.00 | 0.87 | 1.00 | 0.71 | 0.91 | 0.60 | 0.81 | 0.65 | 0.53 | - |
| 9 | 1.00 | 1.00 | 1.00 | 0.92 | 1.00 | 0.75 | 0.96 | 0.63 | 0.86 | 0.69 | 0.56 | - |
| 9-1/2 | 1.00 | 1.00 | 1.00 | 0.97 | 1.00 | 0.79 | 1.00 | 0.67 | 0.90 | 0.72 | 0.59 | - |
| 10 | 1.00 | 1.00 | 1.00 | 1.00 | 1.00 | 0.83 | 1.00 | 0.70 | 0.95 | 0.76 | 0.62 | - |
| 10-1/2 | 1.00 | 1.00 | 1.00 | 1.00 | 1.00 | 0.88 | 1.00 | 0.74 | 1.00 | 0.80 | 0.65 | - |
| 11 | 1.00 | 1.00 | 1.00 | 1.00 | 1.00 | 0.92 | 1.00 | 0.77 | 1.00 | 0.84 | 0.68 | - |
| 11-1/2 | 1.00 | 1.00 | 1.00 | 1.00 | 1.00 | 0.96 | 1.00 | 0.81 | 1.00 | 0.88 | 0.71 | - |
| 12 | 1.00 | 1.00 | 1.00 | 1.00 | 1.00 | 1.00 | 1.00 | 0.84 | 1.00 | 0.91 | 0.74 | - |
| 12-1/2 | 1.00 | 1.00 | 1.00 | 1.00 | 1.00 | 1.00 | 1.00 | 0.88 | 1.00 | 0.95 | 0.78 | - |
| 13 | 1.00 | 1.00 | 1.00 | 1.00 | 1.00 | 1.00 | 1.00 | 0.91 | 1.00 | 0.99 | 0.81 | - |
| 13-1/2 | 1.00 | 1.00 | 1.00 | 1.00 | 1.00 | 1.00 | 1.00 | 0.95 | 1.00 | 1.00 | 0.84 | - |
| 14 | 1.00 | 1.00 | 1.00 | 1.00 | 1.00 | 1.00 | 1.00 | 0.98 | 1.00 | 1.00 | 0.87 | - |
| 14-1/2 | 1.00 | 1.00 | 1.00 | 1.00 | 1.00 | 1.00 | 1.00 | 1.00 | 1.00 | 1.00 | 0.90 | - |
| 15 | 1.00 | 1.00 | 1.00 | 1.00 | 1.00 | 1.00 | 1.00 | 1.00 | 1.00 | 1.00 | 0.93 | - |
| 15-1/2 | 1.00 | 1.00 | 1.00 | 1.00 | 1.00 | 1.00 | 1.00 | 1.00 | 1.00 | 1.00 | 0.96 | - |
| 16 | 1.00 | 1.00 | 1.00 | 1.00 | 1.00 | 1.00 | 1.00 | 1.00 | 1.00 | 1.00 | 0.99 | - |
| 16-1/2 | 1.00 | 1.00 | 1.00 | 1.00 | 1.00 | 1.00 | 1.00 | 1.00 | 1.00 | 1.00 | 1.00 | - |

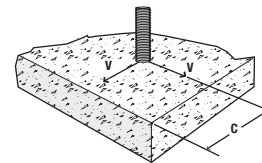
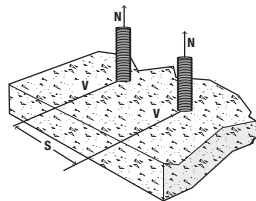

Ultimate and Allowable Load Capacities in Tension for Power-Stud+ SD1 in Grout Filled Concrete Masonry Wall Faces^{1,2,3,4,5,6}

CODE LISTED
ICC-ES ESR-2966



| Nominal Anchor Diameter in. | Nominal Drill Bit Diameter in. | Min. Embed. Depth in. (mm) | Min. Edge Distance in. (mm) | Min. End Distance in. (mm) | Installation Torque T _{inst} ft-lbf (N-m) | Grout-Filled Concrete Masonry | | | |
|-----------------------------|--------------------------------|----------------------------|-----------------------------|----------------------------|--|---------------------------------|----------------------------------|---------------------------------|----------------------------------|
| | | | | | | f'm = 1,500 psi | | f'm = 2,000 psi | |
| | | | | | | Ultimate Load Tension lbs. (kN) | Allowable Load Tension lbs. (kN) | Ultimate Load Tension lbs. (kN) | Allowable Load Tension lbs. (kN) |
| 3/8 | 3/8 ANSI | 2-3/8 (60.3) | 4 (101.6) | 4 (101.6) | 20 (27) | 2,225 (10.0) | 445 (2.0) | 2,670 (12.0) | 535 (2.4) |
| 1/2 | 1/2 ANSI | 2-1/2 (63.5) | 4 (101.6) | 4 (101.6) | 40 (54) | 2,650 (11.9) | 530 (2.4) | 3,180 (14.3) | 635 (2.9) |
| 5/8 | 5/8 ANSI | 3-3/8 (85.7) | 4 (101.6) | 4 (101.6) | 50 (68) | 3,525 (15.9) | 705 (3.2) | 4,230 (19.0) | 845 (3.8) |
| 3/4 | 3/4 ANSI | 3-3/8 (85.7) | 12 (304.8) | 12 (304.8) | 80 (108) | 7,575 (33.7) | 1,515 (6.7) | 8,175 (36.4) | 1,635 (7.3) |
| | | | 20 (508.0) | 20 (508.0) | 80 (108) | 7,575 (33.7) | 1,515 (6.7) | 8,175 (36.4) | 1,635 (7.3) |
| | | 4-3/4 (120.7) | 12 (304.8) | 12 (304.8) | 80 (108) | 7,580 (34.1) | 1,515 (6.8) | 8,755 (39.4) | 1,750 (7.9) |

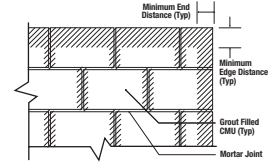

Wall Face Permissible Anchor Locations (Un-hatched Area)

1. Tabulated load values for 3/8", 1/2" and 5/8" diameter anchors are installed in minimum 6" wide, Grade N, Type II, lightweight, medium-weight or normal-weight concrete masonry units conforming to ASTM C 90. Mortar must be minimum Type N. Masonry compressive strength must be at specified minimum at the time of installation.
2. Tabulated load values for 3/4" diameter anchors are installed in minimum 8" wide, Grade N, Type II, lightweight, medium-weight or normal-weight concrete masonry units conforming to ASTM C 90. Mortar must be minimum Type N. Masonry compressive strength must be at specified minimum at the time of installation.
3. Allowable load capacities listed are calculated using an applied safety factor of 5.0.
4. The tabulated values are applicable for anchors installed into grouted masonry wall faces at a critical spacing distance, s_{cr}, between anchors of 16 times the anchor diameter. The spacing distance between two anchors may be reduced to minimum distance, s_{min}, of 8 times the anchor diameter provided the allowable tension loads are multiplied by a reduction factor 0.80 and allowable shear loads are multiplied by a reduction factor of 0.90. Linear interpolation for calculation of allowable loads may be used for intermediate anchor spacing distances.
5. Anchors may be installed in the grouted cells and in cell webs and bed joints not closer than 1-3/8" from head joints. The minimum edge and end distances must also be maintained.
6. Allowable tension values for anchors installed into bed joints of grouted masonry wall faces with a minimum of 12" edge distance and end distance may be increased by 20 percent for the 1/2-inch diameter and 10 percent for the 5/8-inch diameter.

Ultimate and Allowable Load Capacities in Shear for Power-Stud+ SD1 in Grout Filled Concrete Masonry Wall Faces^{1,2,3,4,5}

CODE LISTED
ICC-ES ESR-2966



| Nominal Anchor Diameter in. | Nominal Drill Bit Diameter in. | Min. Embed. Depth in. (mm) | Min. Edge Distance in. (mm) | Min. End Distance in. (mm) | Direction of Loading | Installation Torque T _{inst} ft-lbf (N-m) | Grout-Filled Concrete Masonry | | | |
|-----------------------------|--------------------------------|----------------------------|-----------------------------|----------------------------|---|--|-------------------------------|--------------------------------|-------------------------------|--------------------------------|
| | | | | | | | f'm = 1,500 psi | | f'm = 2,000 psi | |
| | | | | | | | Ultimate Load Shear lbs. (kN) | Allowable Load Shear lbs. (kN) | Ultimate Load Shear lbs. (kN) | Allowable Load Shear lbs. (kN) |
| 3/8 | 3/8 ANSI | 2-3/8 (60.3) | 4 (101.6) | 4 (101.6) | Perpendicular or parallel to wall edge or end | 20 (27) | 2,975 (13.4) | 595 (2.7) | 3,570 (16.1) | 715 (3.2) |
| 1/2 | 1/2 ANSI | 2-1/2 (63.5) | 4 (101.6) | 12 (304.8) | Perpendicular or parallel to wall edge or end | 40 (54) | 2,800 (12.6) | 560 (2.5) | 3,360 (15.1) | 670 (3.0) |
| | | | 12 (304.8) | 4 (101.6) | Parallel to wall end | | 4,025 (18.1) | 805 (3.6) | 4,830 (21.7) | 965 (4.3) |
| | | | 4 (101.6) | 12 (304.8) | Parallel to wall edge | 50 (68) | 3,425 (15.4) | 685 (3.1) | 4,110 (18.5) | 820 (3.7) |
| | | | 12 (304.8) | 4 (101.6) | Parallel to wall end | | 5,325 (24.0) | 1,065 (4.8) | 6,390 (28.8) | 1,280 (5.8) |
| 3/4 | 3/4 ANSI | 3-3/8 (85.7) | 12 (304.8) | 12 (304.8) | Perpendicular or parallel to wall edge or end | 80 (108) | 8,850 (39.4) | 1,770 (7.9) | 9,375 (41.7) | 1,875 (8.3) |
| | | | 20 (508.0) | 20 (508.0) | | | 10,200 (45.4) | 2,040 (9.1) | 10,800 (48.0) | 2,160 (9.6) |
| | | 4-3/4 (120.7) | 12 (304.8) | 12 (304.8) | | | 12,735 (56.7) | 2,545 (11.3) | 12,735 (56.7) | 2,545 (11.3) |
| | | | 20 (508.0) | 20 (508.0) | | | 12,735 (56.7) | 2,545 (11.3) | 12,735 (56.7) | 2,545 (11.3) |

1. Tabulated load values for 3/8", 1/2" and 5/8" diameter anchors are installed in minimum 6" wide, Grade N, Type II, lightweight, medium-weight or normal-weight concrete masonry units conforming to ASTM C 90. Mortar must be minimum Type N. Masonry compressive strength must be at specified minimum at the time of installation.
2. Tabulated load values for 3/4" diameter anchors are installed in minimum 8" wide, Grade N, Type II, lightweight, medium-weight or normal-weight concrete masonry units conforming to ASTM C 90. Mortar must be minimum Type N. Masonry compressive strength must be at specified minimum at the time of installation.
3. Allowable load capacities listed are calculated using an applied safety factor of 5.0.
4. The tabulated values are applicable for anchors installed into grouted masonry wall faces at a critical spacing distance, s_{cr}, between anchors of 16 times the anchor diameter. The spacing distance between two anchors may be reduced to minimum distance, s_{min}, of 8 times the anchor diameter provided the allowable tension loads are multiplied by a reduction factor 0.80 and allowable shear loads are multiplied by a reduction factor of 0.90. Linear interpolation for calculation of allowable loads may be used for intermediate anchor spacing distances.
5. Anchors may be installed in the grouted cells and in cell webs and bed joints not closer than 1-3/8" from head joints. The minimum edge and end distances must also be maintained.

Ultimate and Allowable Load Capacities in Tension for Power-Stud+ SD1 in Grout Filled Concrete Masonry Wall Tops^{1,2,3,4}

CODE LISTED
ICC-ES ESR-2966



| Nominal Anchor Diameter in. | Nominal Drill Bit Diameter in. | Minimum Embed. Depth in. (mm) | Min. Edge Distance in. (mm) | Min. End Distance in. (mm) | Installation Torque T _{inst} ft-lbf (N-m) | Grout-Filled Concrete Masonry | | | |
|-----------------------------|--------------------------------|-------------------------------|-----------------------------|----------------------------|--|---------------------------------|----------------------------------|---------------------------------|----------------------------------|
| | | | | | | f'm = 1,500 psi | | f'm = 2,000 psi | |
| | | | | | | Ultimate Load Tension lbs. (kN) | Allowable Load Tension lbs. (kN) | Ultimate Load Tension lbs. (kN) | Allowable Load Tension lbs. (kN) |
| 3/8 | 3/8 ANSI | 2-3/8 (60.3) | 1-3/4 (44.5) | 12 (304.8) | 20 (27) | 1,475 (6.6) | 295 (1.3) | 1,770 (8.0) | 355 (1.6) |
| 1/2 | 1/2 ANSI | 2-1/2 (63.5) | 2-1/4 (57.1) | | 40 (54) | 2,225 (9.9) | 445 (2.0) | 2,575 (11.5) | 515 (2.3) |
| | | 5 (127) | | | | 3,425 (15.4) | 685 (3.1) | 4,110 (18.5) | 820 (3.7) |
| 5/8 | 5/8 ANSI | 3-3/8 (85.7) | 2-1/4 (57.1) | 50 (68) | 3,825 (17.2) | 765 (3.4) | 4,590 (20.7) | 920 (4.1) | |

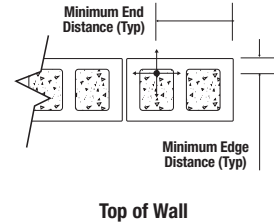

1. Tabulated load values are for anchors installed in minimum 8-inch wide, minimum Grade N, Type II, lightweight, medium-weight or normal-weight concrete masonry units conforming to ASTM C 90. Mortar must be minimum Type N. Masonry compressive strength must be at the specified minimum at the time of installation.
2. Allowable load capacities listed are calculated using and applied safety factor of 5.0. Consideration of safety factors of 10 or higher may be necessary depending upon the application such as life safety.
3. Anchors must be installed in the grouted cells and the minimum edge and end distances must be maintained.
4. The tabulated values are applicable for anchors installed in top of grouted masonry walls at a critical spacing distance, s_c, between anchors of 16 times the anchor diameter.

Ultimate and Allowable Load Capacities in Shear for Power-Stud+ SD1 in Grout Filled Concrete Masonry Wall Tops^{1,2,3,4}

CODE LISTED
ICC-ES ESR-2966



| Nominal Anchor Diameter in. | Nominal Drill Bit Diameter in. | Minimum Embed. Depth in. (mm) | Min. Edge Distance in. (mm) | Min. End Distance in. (mm) | Direction of Loading | Installation Torque T _{inst} ft-lbf (N-m) | Grout-Filled Concrete Masonry | | | |
|-----------------------------|--------------------------------|---|-----------------------------|----------------------------|---|--|-------------------------------|--------------------------------|-------------------------------|--------------------------------|
| | | | | | | | f'm = 1,500 psi | | f'm = 2,000 psi | |
| | | | | | | | Ultimate Load Shear lbs. (kN) | Allowable Load Shear lbs. (kN) | Ultimate Load Shear lbs. (kN) | Allowable Load Shear lbs. (kN) |
| 3/8 | 3/8 ANSI | 2-3/8 (60.3) | 1-3/4 (44.5) | 12 (304.8) | Perpendicular to wall toward minimum edge | 20 (27) | 1,150 (5.2) | 230 (1.0) | 1,380 (6.2) | 275 (1.2) |
| | | | | | Parallel to wall edge | | 2,425 (10.9) | 485 (2.2) | 2,910 (13.1) | 580 (2.6) |
| 1/2 | 1/2 ANSI | 2-1/2 (63.5) | 2-1/4 (57.1) | 12 (304.8) | Any | 40 (54) | 1,150 (5.2) | 230 (1.0) | 1,380 (6.2) | 275 (1.2) |
| | | Perpendicular to wall toward minimum edge | | | 1,400 (6.3) | | 280 (1.3) | 1,680 (7.6) | 325 (1.5) | |
| | | Parallel to wall edge | | | 2,825 (12.7) | | 565 (2.5) | 3,390 (15.3) | 680 (3.1) | |
| 5/8 | 5/8 ANSI | 3-3/8 (85.7) | 2-1/4 (57.1) | 12 (304.8) | Any | 50 (68) | 1,150 (5.2) | 230 (1.0) | 1,380 (6.2) | 275 (1.2) |
| | | Perpendicular to wall toward minimum edge | | | 1,700 (7.7) | | 340 (1.5) | 2,040 (9.2) | 410 (1.8) | |
| | | Parallel to wall edge | | | 3,525 (15.9) | | 705 (3.2) | 4,230 (19.0) | 845 (3.8) | |

1. Tabulated load values are for anchors installed in minimum 6-inch wide, minimum Grade N, Type II, lightweight, medium-weight or normal-weight concrete masonry units conforming to ASTM C 90. Mortar must be minimum Type N. Masonry compressive strength must be at the specified minimum at the time of installation.
2. Allowable load capacities listed are calculated using an applied safety factor of 5.0. Consideration of safety factors of 10 or higher may be necessary depending upon the application such as life safety.
3. Anchors must be installed in the grouted cells and the minimum edge and end distances must be maintained.
4. The tabulated values are applicable for anchors installed in top of grouted masonry walls at a critical spacing distance, s_c, between anchors of 16 times the anchor diameter.

MECHANICAL ANCHORS

POWER-STUD® + SD1
Wedge Expansion Anchor

STRENGTH DESIGN (SD)

Power-Stud+ SD1 Anchor Installation Specifications in Concrete¹

CODE LISTED
ICC-ES ESR-2818



| Anchor Property / Setting Information | Notation | Units | Nominal Anchor Diameter | | | | | | | | | | |
|---|-------------------|----------------|-------------------------|-------------|--------------|-------------|--------------|--------------|--------------|--------------|--------------|-------------|-------------|
| | | | 1/4 inch | 3/8 inch | 1/2 inch | | 5/8 inch | 3/4 inch | 7/8 inch | 1 inch | 1-1/4 inch | | |
| Anchor diameter | d _a | in. (mm) | 0.250 (6.4) | 0.375 (9.5) | 0.500 (12.7) | | 0.625 (15.9) | 0.750 (19.1) | 0.875 (22.2) | 1.000 (25.4) | 1.250 (31.8) | | |
| Minimum diameter of hole clearance in fixture | d _h | in. (mm) | 5/16 (7.5) | 7/16 (11.1) | 9/16 (14.3) | | 11/16 (17.5) | 13/16 (20.6) | 1 (25.4) | 1-1/8 (28.6) | 1-3/8 (34.9) | | |
| Nominal drill bit diameter | d _{bit} | in. | 1/4 ANSI | 3/8 ANSI | 1/2 ANSI | | 5/8 ANSI | 3/4 ANSI | 7/8 ANSI | 1 ANSI | 1-1/4 ANSI | | |
| Nominal embedment depth | h _{nom} | in. (mm) | 1-3/4 (44) | 2-3/8 (60) | 2-1/2 (64) | 3-3/4 (95) | 3-3/8 (86) | 4-5/8 (117) | 4 (102) | 5-5/8 (143) | 4-1/2 (114) | 5-1/2 (140) | 6-1/2 (165) |
| Effective embedment depth | h _{ef} | in. (mm) | 1.50 (38) | 2.00 (51) | 2.00 (51) | 3.25 (83) | 2.75 (70) | 4.00 (102) | 3.125 (79) | 4.75 (114) | 3.50 (89) | 4.375 (111) | 5.375 (137) |
| Minimum hole depth | h _{hole} | in. (mm) | 1-7/8 (48) | 2-1/2 (64) | 2-3/4 (70) | 4 (102) | 3-3/4 (95) | 5 (127) | 4-1/4 (108) | 5-7/8 (149) | 4-7/8 (124) | 5-7/8 (149) | 7-1/4 (184) |
| Minimum overall anchor length ² | ℓ _{anch} | in. (mm) | 2-1/4 (57) | 3 (76) | 3-3/4 (95) | 4-1/2 (114) | 4-1/2 (114) | 6 (152) | 5-1/2 (140) | 7 (178) | 8 (203) | 9 (229) | 9 (229) |
| Installation torque ⁶ | T _{inst} | ft.-lbf. (N-m) | 4 (5) | 20 (27) | 40 (54) | | 80 (108) | 110 (149) | 175 (237) | 225 (305) | 275 (375) | 375 (508) | |
| Torque wrench/socket size | - | in. | 7/16 | 9/16 | 3/4 | | 15/16 | 1-1/8 | 1-5/16 | 1-1/2 | 1-7/8 | | |
| Nut height | - | in. | 7/32 | 21/64 | 7/16 | | 35/64 | 41/64 | 3/4 | 55/64 | 1-1/16 | | |

Anchors Installed in Concrete Construction

| | | | | | | | | | | | | | | | | | | |
|--|------------------|----------|------------|-------------|------------|------------|-------------|------------|---------|------------|----------|-------------|--------------|----------|-------------|-------------|---------|---------|
| Minimum member thickness | h _{min} | in. (mm) | 3-1/4 (83) | 3-3/4 (95) | 4 (102) | 4 (102) | 6 (152) | 6 (152) | 7 (178) | 6 (152) | 10 (254) | 10 (254) | 10 (254) | 12 (305) | | | | |
| Minimum edge distance | C _{min} | in. (mm) | 1-3/4 (45) | 6 (152) | 2-3/4 (70) | 2-1/4 (57) | 6 (152) | 3-1/4 (95) | 4 (102) | 2-3/4 (70) | 6 (152) | 5-1/2 (140) | 4-1/4 (108) | 5 (127) | 6 (152) | 7 (178) | 8 (203) | 8 (203) |
| Minimum spacing distance | S _{min} | in. (mm) | 2-1/4 (57) | 3-1/2 (89) | 9 (229) | 3-3/4 (95) | 4-1/2 (114) | 10 (254) | 5 (127) | 6 (152) | 6 (152) | 11 (270) | 4-1/4 (108) | 6 (152) | 6-1/2 (165) | 6-1/2 (165) | 8 (203) | 8 (203) |
| Critical edge distance (uncracked concrete only) | C _{ac} | in. (mm) | 3-1/2 (89) | 6-1/2 (165) | | 8 (203) | | 8 (203) | 6 (152) | 10 (254) | 11 (279) | 16 (406) | 11-1/2 (292) | 12 (305) | 12 (305) | 20 (508) | | |

Anchors Installed in the Topside of Concrete-filled Steel Deck Assemblies⁴

| | | | | | | | | | | | | |
|--|---------------------------|----------|------------|-------------|-------------|------------|------------|------------|------------|------------|------------|------------|
| Minimum member topping thickness | h _{min,deck} | in. (mm) | 3-1/4 (83) | 3-1/4 (83) | 3-1/4 (83) | See note 3 | See note 3 | See note 3 | See note 3 | See note 3 | See note 3 | See note 3 |
| Minimum edge distance | C _{min,deck,top} | in. (mm) | 1-3/4 (45) | 2-3/4 (70) | 4-1/2 (114) | | | | | | | |
| Minimum spacing distance | S _{min,deck,top} | in. (mm) | 2-1/4 (57) | 4 (102) | 6-1/2 (165) | | | | | | | |
| Critical edge distance (uncracked concrete only) | C _{ac,deck,top} | in. (mm) | 3-1/2 (89) | 6-1/2 (165) | 6 (152) | | | | | | | |

Anchors Installed Through the Soffit of Steel Deck Assemblies into Concrete⁵

| | | | | | | | | | | |
|--|-----------------------|----------|----------------|-------------|-------------|----------------|----------------|----------------|----------------|----------------|
| Minimum member topping thickness (see detail in Figure 2A) | h _{min,deck} | in. (mm) | Not Applicable | 3-1/4 (95) | 3-1/4 (95) | 3-1/4 (95) | 3-1/4 (95) | Not Applicable | Not Applicable | Not Applicable |
| Minimum edge distance, lower flute (see detail in Figure 2A) | C _{min} | in. (mm) | | 1-1/4 (32) | 1-1/4 (32) | 1-1/4 (32) | 1-1/4 (32) | | | |
| Minimum axial spacing distance along flute (see detail in Figure 2A) | S _{min} | in. (mm) | | 6-3/4 (171) | 6-3/4 (171) | 9-3/4 (248) | 8-1/4 (210) | | | |
| Minimum member topping thickness (see detail in Figure 2B) | h _{min,deck} | in. (mm) | | 2-1/4 (57) | 2-1/4 (57) | Not Applicable | Not Applicable | Not Applicable | Not Applicable | Not Applicable |
| Minimum edge distance, lower flute (see detail in Figure 2B) | C _{min} | in. (mm) | | 3/4 (19) | 3/4 (19) | | | | | |
| Minimum axial spacing distance along flute (see detail in Figure 2B) | S _{min} | in. (mm) | | 6 (152) | 6 (152) | | | | | |

For SI: 1 inch = 25.4 mm, 1 ft-lbf = 1.356 N-m.

- The information presented in this table is to be used in conjunction with the design criteria of ACI 318-14 Chapter 17 or ACI 318-11 Appendix D, as applicable.
- The listed minimum overall anchor length is based on anchor sizes commercially available at the time of publication compared with the requirements to achieve the minimum nominal embedment depth, nut height and washer thickness, and consideration of a possible fixture attachment.
- The 1/4 -inch-diameter (6.4 mm) anchors may be installed in the topside of uncracked concrete-filled steel deck assemblies where concrete thickness above the upper flute meets the minimum member thicknesses specified in this table. The 3/8 -inch (9.5 mm) through 1-1/4 -inch-diameter (31.8 mm) anchors may be installed in the topside of cracked and uncracked concrete-filled steel deck assemblies where concrete thickness above the upper flute meets the minimum member thicknesses specified in this table under Anchors Installed in Concrete Construction.
- For installations in the topside of concrete-filled steel deck assemblies, see the installation detail in Figure 1.
- For installations through the soffit of steel deck assemblies into concrete, see the installation details in Figures 2A and 2B. In accordance with the figures, anchors shall have an axial spacing along the flute equal to the greater of 3h_{ef} or 1.5 times the flute width.
- For installation of 5/8 -inch diameter anchors through the soffit of the steel deck into concrete, the installation torque is 50 ft.-lbf. For installation of 3/4 -inch-diameter anchors through the soffit of the steel deck into concrete, installation torque is 80 ft.-lbf.

Power-Stud+ SD1 Anchor Detail

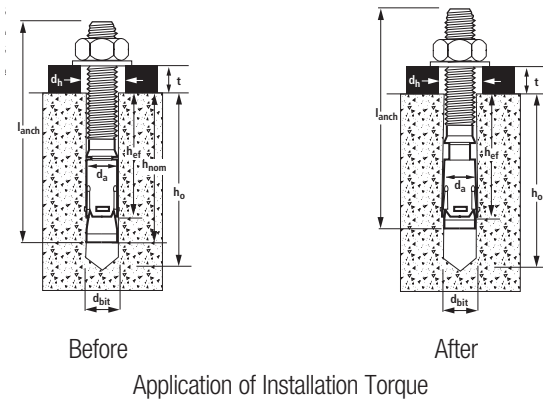

Application of Installation Torque

Interpolation of Minimum Edge Distance and Anchor Spacing

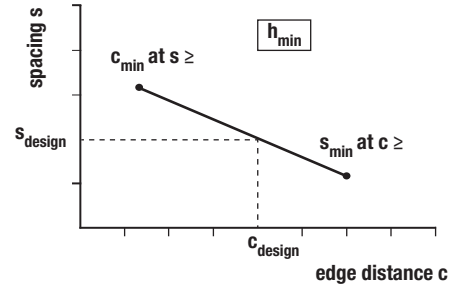

This interpolation applies to the cases when two sets of minimum edge distances, c_{min} , and minimum spacing distances, s_{min} , are given in the SD Installation Specifications for Concrete table for a given anchor diameter under the same effective embedment depth, h_{ef} , and corresponding minimum member thickness, h_{min} .

Figure 1 - Power-Stud+ SD1 Installation Detail for Anchors in the Topside Of Concrete Filled Steel Deck Floor and Roof Assemblies (See Dimensional Profile Requirements)

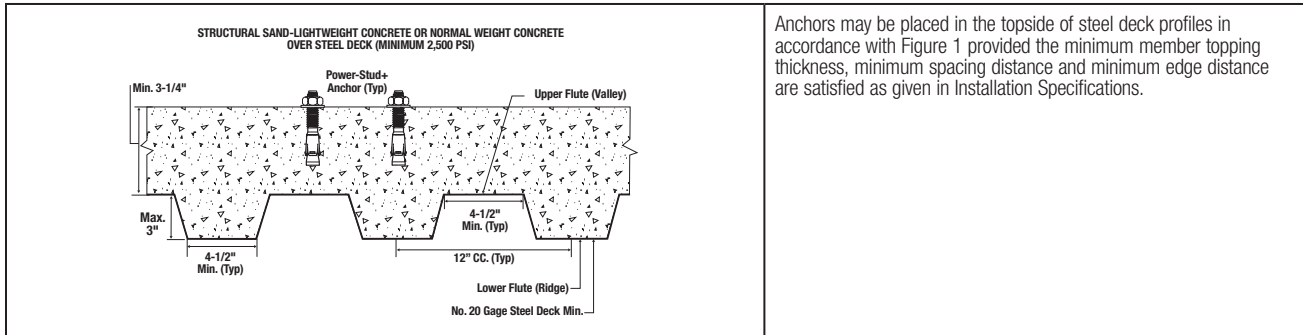

Anchors may be placed in the topside of steel deck profiles in accordance with Figure 1 provided the minimum member topping thickness, minimum spacing distance and minimum edge distance are satisfied as given in Installation Specifications.

Figure 2A - Power-Stud+ SD1 Installation Detail for Anchors in the Soffit Of Concrete Over Steel Deck Floor and Roof Assemblies (See Dimensional Profile Requirements)

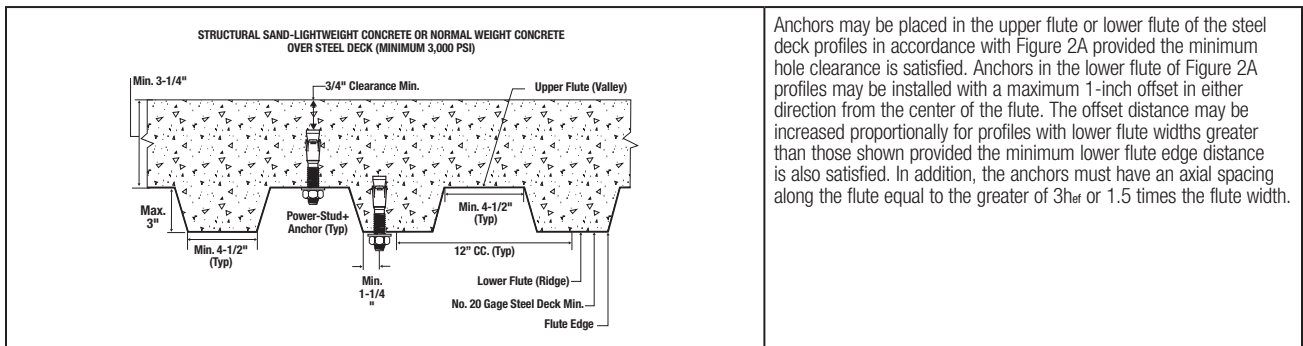

Anchors may be placed in the upper flute or lower flute of the steel deck profiles in accordance with Figure 2A provided the minimum hole clearance is satisfied. Anchors in the lower flute of Figure 2A profiles may be installed with a maximum 1-inch offset in either direction from the center of the flute. The offset distance may be increased proportionally for profiles with lower flute widths greater than those shown provided the minimum lower flute edge distance is also satisfied. In addition, the anchors must have an axial spacing along the flute equal to the greater of $3h_{ef}$ or 1.5 times the flute width.

Figure 2B - Power-Stud+ SD1 Installation Detail for Anchors in the Soffit Of Concrete Over Steel Deck Floor and Roof Assemblies (See Dimensional Profile Requirements)

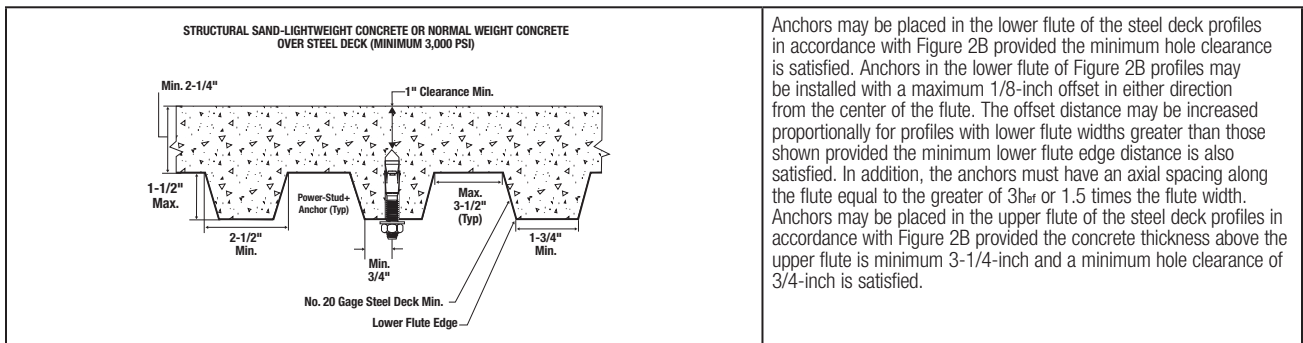

Anchors may be placed in the lower flute of the steel deck profiles in accordance with Figure 2B provided the minimum hole clearance is satisfied. Anchors in the lower flute of Figure 2B profiles may be installed with a maximum 1/8-inch offset in either direction from the center of the flute. The offset distance may be increased proportionally for profiles with lower flute widths greater than those shown provided the minimum lower flute edge distance is also satisfied. In addition, the anchors must have an axial spacing along the flute equal to the greater of $3h_{ef}$ or 1.5 times the flute width. Anchors may be placed in the upper flute of the steel deck profiles in accordance with Figure 2B provided the concrete thickness above the upper flute is minimum 3-1/4-inch and a minimum hole clearance of 3/4-inch is satisfied.

Tension Design Information for Power-Stud+ SD1 Anchor in Concrete
(For use with load combinations taken from ACI 318-14, Section 5.3 or
ACI 318-11, Section 9.2)^{1,2}

CODE LISTED
 ICC-ES ESR-2818



| Design Characteristic | Notation | Units | Nominal Anchor Diameter | | | | | | | | | | |
|--|-------------------|------------------------------------|---------------------------------|---------------|---------------|----------------|----------------|----------------|----------------|----------------|----------------|----------------|---------------|
| | | | 1/4 inch | 3/8 inch | 1/2 inch | 5/8 inch | 3/4 inch | 7/8 inch | 1 inch | 1-1/4 inch | | | |
| Anchor category | 1, 2 or 3 | - | 1 | 1 | 1 | 1 | 1 | 1 | 1 | 1 | 1 | 1 | |
| STEEL STRENGTH IN TENSION³ | | | | | | | | | | | | | |
| Minimum specified yield strength | f_{ya} | ksi (N/mm ²) | 88.0 (606) | 88.0 (606) | 80.0 (551) | 80.0 (551) | 64.0 (441) | 58.0 (400) | 58.0 (400) | 58.0 (400) | 58.0 (400) | 58.0 (400) | |
| Minimum specified ultimate tensile strength (neck) | f_{uta}^{12} | ksi (N/mm ²) | 110.0 (758) | 110.0 (758) | 100.0 (689) | 100.0 (689) | 80.0 (552) | 75.0 (517) | 75.0 (517) | 75.0 (517) | 75.0 (517) | 75.0 (517) | |
| Effective tensile stress area (neck) | $A_{se,N}$ | in ² (mm ²) | 0.0220 (14.2) | 0.0531 (34.3) | 0.1018 (65.7) | 0.1626 (104.9) | 0.2376 (150.9) | 0.327 (207.5) | 0.430 (273.1) | 0.430 (273.1) | 0.430 (273.1) | 0.762 (484) | |
| Steel strength in tension ⁴ | N_{sa}^{12} | lb (kN) | 2,255 (10.0) | 5,455 (24.3) | 9,080 (40.4) | 14,465 (64.3) | 19,000 (84.5) | 24,500 (109.0) | 32,250 (143.5) | 32,250 (143.5) | 32,250 (143.5) | 56,200 (250) | |
| Reduction factor for steel strength ⁵ | ϕ | - | 0.75 | | | | | | | | | | |
| CONCRETE BREAKOUT STRENGTH IN TENSION⁶ | | | | | | | | | | | | | |
| Effective embedment depth | η_{ef} | in. (mm) | 1.50 (38) | 2.00 (51) | 2.00 (51) | 3.25 (83) | 2.75 (70) | 4.00 (102) | 3.125 (79) | 4.75 (114) | 3.50 (89) | 4.375 (111) | 5.375 (137) |
| Effectiveness factor for uncracked concrete | k_{uncr} | - | 24 | 24 | 24 | 24 | 24 | 24 | 24 | 24 | 24 | 24 | 27 |
| Effectiveness factor for cracked concrete | k_{cr} | - | Not Applicable | 17 | 17 | 17 | 17 | 21 | 17 | 21 | 24 | 24 | 24 |
| Modification factor for cracked and uncracked concrete ⁹ | $\Psi_{c,N}^{12}$ | - | 1.0 | 1.0 | 1.0 | 1.0 | 1.0 | 1.0 | 1.0 | 1.0 | 1.0 | 1.0 | 1.0 |
| Critical edge distance (uncracked concrete only) | c_{ac} | in. (mm) | See Installation Specifications | | | | | | | | | | |
| Reduction factor for concrete breakout strength ³ | ϕ | - | 0.65 (Condition B) | | | | | | | | | | |
| PULLOUT STRENGTH IN TENSION (NON SEISMIC-APPLICATIONS)^{8,9} | | | | | | | | | | | | | |
| Characteristic pullout strength, uncracked concrete (2,500 psi) ⁶ | $N_{p,uncr}$ | lb (kN) | See note 7 | 2,865 (12.8) | 3,220 (14.3) | 5,530 (24.6) | See note 7 | See note 7 | See note 7 | See note 7 | See note 7 | See note 7 | See note 7 |
| Characteristic pullout strength, cracked concrete (2,500 psi) ⁶ | $N_{p,cr}$ | lb (kN) | Not Applicable | 2,035 (9.1) | See note 7 | 2,505 (11.2) | See note 7 | 4,450 (19.8) | See note 7 | See note 7 | See note 7 | See note 7 | 11,350 (50.5) |
| Reduction factor for pullout strength ³ | ϕ | - | 0.65 (Condition B) | | | | | | | | | | |
| PULLOUT STRENGTH IN TENSION FOR SEISMIC APPLICATIONS^{8,9} | | | | | | | | | | | | | |
| Characteristic pullout strength, seismic (2,500 psi) ^{6,10} | $N_{p,eq}^{12}$ | lb (kN) | Not Applicable | 2,035 (9.1) | See note 7 | 2,505 (11.2) | See note 7 | 4,450 (19.8) | See note 7 | See note 7 | See note 7 | See note 7 | 11,350 (50.5) |
| Reduction factor for pullout strength, seismic ³ | ϕ | - | 0.65 (Condition B) | | | | | | | | | | |
| PULLOUT STRENGTH IN TENSION FOR ANCHORS INSTALLED THROUGH THE SOFFIT OF SAND-LIGHTWEIGHT AND NORMAL-WEIGHT CONCRETE OVER STEEL DECK | | | | | | | | | | | | | |
| Characteristic pullout strength, uncracked concrete over steel deck (Figure 2A) ^{6,11} | $N_{p,deck,uncr}$ | lb (kN) | Not Applicable | 1,940 (8.6) | 3,205 (14.2) | 2,795 (12.4) | 3,230 (14.4) | Not Applicable | Not Applicable | Not Applicable | Not Applicable | Not Applicable | |
| Characteristic pullout strength, cracked concrete over steel deck (Figure 2A) ^{6,11} | $N_{p,deck,cr}$ | lb (kN) | | 1,375 (6.1) | 2,390 (10.6) | 1,980 (8.8) | 2,825 (12.4) | | | | | | |
| Characteristic pullout strength, cracked concrete over steel deck, seismic (Figure 2A) ^{6,11} | $N_{p,deck,eq}$ | lb (kN) | | 1,375 (6.1) | 2,390 (10.6) | 1,980 (8.8) | 2,825 (12.4) | | | | | | |
| Characteristic pullout strength, uncracked concrete over steel deck (Figure 2B) ^{6,11} | $N_{p,deck,uncr}$ | lb (kN) | | 1,665 (7.4) | 1,900 (8.5) | Not Applicable | Not Applicable | | | | | | |
| Characteristic pullout strength, cracked concrete over steel deck (Figure 2B) ^{6,11} | $N_{p,deck,cr}$ | lb (kN) | | 1,180 (5.2) | 1,420 (6.3) | | | | | | | | |
| Characteristic pullout strength, cracked concrete over steel deck, seismic (Figure 2B) ^{6,11} | $N_{p,deck,eq}$ | lb (kN) | | 1,180 (5.2) | 1,420 (6.3) | | | | | | | | |
| Reduction factor for pullout strength, steel deck ³ | ϕ | - | 0.65 (Condition B) | | | | | | | | | | |

- For SI: 1 inch = 25.4 mm; 1 ksi = 6.894 N/mm²; 1 lbf = 0.0044 kN.
- The data in this table is intended to be used with the design provisions of ACI 318-14 Chapter 17 or ACI 318 -11 Appendix D, as applicable; for anchors resisting seismic load combinations the additional requirements of ACI 318-14 17.2.3 or ACI 318-11 D.3.3, as applicable, must apply.
 - Installation must comply with published instructions and details.
 - All values of ϕ apply to the load combinations of IBC Section 1605.2, ACI 318-14 Section 5.3 or ACI 318-11 Section 9.2, as applicable. If the load combinations of ACI 318-11 Appendix C are used, then the appropriate value of ϕ must be determined in accordance with ACI 318-11 D.4.4. For reinforcement that meets ACI 318-14 Chapter 17 or ACI 318-11 Appendix D requirements for Condition A, see ACI 318-14 17.3.3(c) or ACI 318-11 D.4.3(c), as applicable, for the appropriate ϕ factor when the load combinations of IBC Section 1605.2, ACI 318-14 Section 5.3 or ACI 318-11 Section 9.2, as applicable, are used.
 - The Power-Stud+ SD1 is considered a ductile steel element as defined by ACI 318-14 2.3 or ACI 318-11 D.1, as applicable. Tabulated values for steel strength in tension are based on test results per ACI 355.2 and must be used for design.
 - For all design cases use $\Psi_{c,N} = 1.0$. The appropriate effectiveness factor for cracked concrete (k_{cr}) or uncracked concrete (k_{uncr}) must be used.
 - For all design cases use $\Psi_{c,P} = 1.0$. For concrete compressive strength greater than 2,500 psi $N_m = (\text{pullout strength from table}) \cdot (\text{specified concrete compressive strength} / 2,500)^{0.5}$. For concrete over steel deck the value of 2,500 must be replaced with the value of 3,000.
 - Pullout strength does not control design of indicated anchors. Do not calculate pullout strength for indicated anchor size and embedment.
 - Anchors are permitted to be used in lightweight concrete provided the modification factor λ_a equal to 0.8λ is applied to all values of $\sqrt{f'_c}$ affecting N_m and V_n . λ shall be determined in accordance with the corresponding version of ACI 318.
 - For anchors in the topside of concrete-filled steel deck assemblies, see Figure 1.
 - Tabulated values for characteristic pullout strength in tension are for seismic applications and based on test results in accordance with ACI 355.2, Section 9.5.
 - Values for $N_{p,deck}$ are for sand-lightweight concrete (f'_c , min = 3,000 psi) and additional lightweight concrete reduction factors need not be applied. In addition, evaluation for the concrete breakout capacity in accordance with ACI 318-14 17.4.2 or ACI 318-11 D.5.2, as applicable, is not required for anchors installed in the deck soffit (flute).

Shear Design Information for Power-Stud+ SD1 Anchor in Concrete
(For use with load combinations taken from ACI 318-14, Section 5.3 or ACI 318-11, Section 9.2)^{1,2}

CODE LISTED
ICC-ES ESR-2818



| Design Characteristic | Notation | Units | Nominal Anchor Diameter | | | | | | | | | | |
|---|------------------|------------------------------------|-------------------------|---------------|---------------|----------------|----------------|----------------|----------------|----------------|----------------|----------------|-------------|
| | | | 1/4 inch | 3/8 inch | 1/2 inch | 5/8 inch | 3/4 inch | 7/8 inch | 1 inch | 1-1/4 inch | | | |
| Anchor category | 1, 2 or 3 | - | 1 | 1 | 1 | 1 | 1 | 1 | 1 | 1 | 1 | 1 | |
| STEEL STRENGTH IN SHEAR³ | | | | | | | | | | | | | |
| Minimum specified yield strength (threads) | f_{ya} | ksi (N/mm ²) | 70.0 (482) | 80.0 (552) | 70.4 (485) | 70.4 (485) | 64.0 (441) | 58.0 (400) | 58.0 (400) | 58.0 (400) | | | |
| Minimum specified ultimate strength (threads) | f_{uta} | ksi (N/mm ²) | 88.0 (606) | 100.0 (689) | 88.0 (607) | 88.0 (607) | 80.0 (552) | 75.0 (517) | 75.0 (517) | 75.0 (517) | | | |
| Effective tensile stress area (threads) | $A_{se,v}$ | in ² (mm ²) | 0.0318 (20.5) | 0.0775 (50.0) | 0.1419 (91.5) | 0.2260 (145.8) | 0.3345 (212.4) | 0.462 (293.4) | 0.6060 (384.8) | 0.969 (615) | | | |
| Steel strength in shear ⁴ | V_{sa} | lb (kN) | 925 (4.1) | 2,990 (13.3) | 4,620 (20.6) | 9,030 (40.2) | 10,640 (47.3) | 11,655 (54.8) | 8,820 (39.2) | 10,935 (48.6) | 17,750 (79.0) | | |
| Reduction factor for steel strength ³ | ϕ | - | 0.65 | | | | | | | | | | |
| CONCRETE BREAKOUT STRENGTH IN SHEAR^{5,7} | | | | | | | | | | | | | |
| Load bearing length of anchor (h_{ef} or $8d_a$, whichever is less) | ℓ_e | in. (mm) | 1.50 (38) | 2.00 (51) | 2.00 (51) | 3.25 (83) | 2.75 (70) | 4.00 (102) | 3.125 (79) | 4.75 (114) | 3.50 (88.9) | 4.375 (111) | 5.375 (137) |
| Nominal anchor diameter | d_a | in. (mm) | 0.250 (6.4) | 0.375 (9.5) | 0.500 (12.7) | 0.625 (15.9) | 0.750 (19.1) | 0.875 (22.2) | 1.000 (25.4) | 1.25 (31.8) | | | |
| Reduction factor for concrete breakout ³ | ϕ | - | 0.70 (Condition B) | | | | | | | | | | |
| PRYOUT STRENGTH IN SHEAR^{5,7} | | | | | | | | | | | | | |
| Coefficient for prout strength (1.0 for $h_{ef} < 2.5$ in., 2.0 for $h_{ef} \geq 2.5$ in.) | k_{cp} | - | 1.0 | 1.0 | 1.0 | 2.0 | 2.0 | 2.0 | 2.0 | 2.0 | 2.0 | 2.0 | |
| Effective embedment | h_{ef} | in. (mm) | 1.50 (38) | 2.00 (51) | 2.00 (51) | 3.25 (83) | 2.75 (70) | 4.00 (102) | 3.125 (79) | 4.75 (114) | 3.50 (88.9) | 4.375 (111) | 5.375 (137) |
| Reduction factor for prout strength ³ | ϕ | - | 0.70 (Condition B) | | | | | | | | | | |
| STEEL STRENGTH IN SHEAR FOR SEISMIC APPLICATIONS | | | | | | | | | | | | | |
| Steel strength in shear, seismic ⁸ | $V_{sa,eq}$ | lb (kN) | N/A | 2,440 (10.9) | 3,960 (17.6) | 6,000 (26.7) | 8,580 (38.2) | 9,635 (42.9) | 8,820 (39.2) | 9,845 (43.8) | 17,750 (79.0) | | |
| Reduction factor for steel strength in shear for seismic ³ | ϕ | - | 0.65 | | | | | | | | | | |
| STEEL STRENGTH IN SHEAR FOR ANCHORS INSTALLED THROUGH THE SOFFIT OF SAND-LIGHTWEIGHT AND NORMAL-WEIGHT CONCRETE OVER STEEL DECK^{9,10} | | | | | | | | | | | | | |
| Steel strength in shear, concrete over steel deck (Figure 2A) ⁹ | $V_{sa,deck}$ | lb (kN) | Not Applicable | 2,120 (9.4) | 2,290 (10.2) | 3,710 (16.5) | 5,505 (24.5) | Not Applicable | Not Applicable | Not Applicable | Not Applicable | Not Applicable | |
| Steel strength in shear, concrete over steel deck, seismic (Figure 2A) ⁹ | $V_{sa,deck,eq}$ | lb (kN) | | 2,120 (9.4) | 2,290 (10.2) | 3,710 (16.5) | 4,570 (20.3) | | | | | | |
| Steel strength in shear, concrete over steel deck (Figure 2B) ⁹ | $V_{sa,deck}$ | lb (kN) | | 2,120 (9.4) | 2,785 (12.4) | Not Applicable | Not Applicable | | | | | | |
| Steel strength in shear, concrete over steel deck, seismic (Figure 2B) ⁹ | $V_{sa,deck,eq}$ | lb (kN) | | 2,120 (9.4) | 2,785 (12.4) | | | | | | | | |
| Reduction factor for steel strength in shear, steel deck ³ | ϕ | - | 0.65 | | | | | | | | | | |

For St: 1 inch = 25.4 mm; 1 ksi = 6.894 N/mm²; 1 lbf = 0.0044 kN.

- The data in this table is intended to be used with the design provisions of ACI 318-14 Chapter 17 or ACI 318-11 Appendix D, as applicable; for anchors resisting seismic load combinations the additional requirements of ACI 318-14 17.2.3 or ACI 318-11 D.3.3, as applicable, must apply.
- Installation must comply with published instructions and details.
- All values of ϕ were determined from the load combinations of IBC Section 1605.2, ACI 318-14 Section 5.3 or ACI 318-11 Section 9.2. If the load combinations of ACI 318-11 Appendix C are used, then the appropriate value of ϕ must be determined in accordance with ACI 318-11 D.4.4. For reinforcement that meets ACI 318-14 Chapter 17 or ACI 318-11 Appendix D requirements for Condition A, see ACI 318-14 17.3.3(c) or ACI 318-11 D.4.3(c), as applicable, for the appropriate ϕ factor when the load combinations of IBC Section 1605.2, ACI 318-14 Section 5.3 or ACI 318-11 Section 9.2, as applicable, are used.
- The Power-Stud+ SD1 is considered a ductile steel element as defined by ACI 318-14 2.3 or ACI 318-11 D.1, as applicable.
- Tabulated values for steel strength in shear must be used for design. These tabulated values are lower than calculated results using equation D-20 in ACI 318-08.
- Anchors are permitted to be used in lightweight concrete provided the modification factor λ_a equal to 0.8λ is applied to all values of $\sqrt{f'_c}$ affecting N_n and V_n . λ shall be determined in accordance with the corresponding version of ACI 318.
- For anchors in the topside of concrete-filled steel deck assemblies, see Figure 1.
- Tabulated values for steel strength in shear are for seismic applications and based on test results in accordance with ACI 355.2, Section 9.6.
- Tabulated values for $V_{sa,deck}$ and $V_{sa,deck,eq}$ are for sand-lightweight concrete (f'_c , min = 3,000 psi); additional lightweight concrete reduction factors need not be applied. In addition, evaluation for the concrete breakout capacity in accordance with ACI 318-14 17.5.2 or ACI 318-11 D.6.2, as applicable, and the prout capacity in accordance with ACI 318-14 17.5.3 or ACI 318-11 D.6.3, as applicable, are not required for anchors installed in the deck soffit (flute).
- Shear loads for anchors installed through steel deck into concrete may be applied in any direction.

STRENGTH DESIGN PERFORMANCE DATA

Factored design strength ϕN_n and ϕV_n
 Calculated in accordance with ACI 318-14 Chapter 17
 Compliant with the International Building Code



Tension and Shear Design Strengths for Power-Stud+ SD1 in Cracked Concrete¹⁻⁶

| Nominal Anchor Diameter (in.) | Nominal Embed. h_{nom} (in.) | Minimum Concrete Compressive Strength | | | | | | | | | |
|-------------------------------|--------------------------------|---------------------------------------|-------------------------|---------------------------|-------------------------|---------------------------|-------------------------|---------------------------|-------------------------|---------------------------|-------------------------|
| | | $f'_c = 2,500$ psi | | $f'_c = 3,000$ psi | | $f'_c = 4,000$ psi | | $f'_c = 6,000$ psi | | $f'_c = 8,000$ psi | |
| | | ϕN_n Tension (lbs.) | ϕV_n Shear (lbs.) | ϕN_n Tension (lbs.) | ϕV_n Shear (lbs.) | ϕN_n Tension (lbs.) | ϕV_n Shear (lbs.) | ϕN_n Tension (lbs.) | ϕV_n Shear (lbs.) | ϕN_n Tension (lbs.) | ϕV_n Shear (lbs.) |
| 1/4 | 1-3/4 | - | - | - | - | - | - | - | - | - | - |
| 3/8 | 2-3/8 | 1,325 | 1,685 | 1,450 | 1,845 | 1,675 | 1,945 | 2,050 | 1,945 | 2,365 | 1,945 |
| 1/2 | 2-1/2 | 1,565 | 1,685 | 1,710 | 1,845 | 1,975 | 2,130 | 2,420 | 2,605 | 2,795 | 3,005 |
| | 3-3/4 | 1,630 | 3,005 | 1,785 | 3,005 | 2,060 | 3,005 | 2,520 | 3,005 | 2,915 | 3,005 |
| 5/8 | 3-3/8 | 2,520 | 3,125 | 2,760 | 3,425 | 3,185 | 3,955 | 3,905 | 4,845 | 4,505 | 5,590 |
| | 4-5/8 | 2,895 | 5,870 | 3,170 | 5,870 | 3,660 | 5,870 | 4,480 | 5,870 | 5,175 | 5,870 |
| 3/4 | 4 | 3,770 | 6,210 | 4,130 | 6,800 | 4,770 | 6,915 | 5,840 | 6,915 | 6,735 | 6,915 |
| | 5-5/8 | 5,720 | 7,575 | 6,265 | 7,575 | 7,235 | 7,575 | 8,860 | 7,575 | 10,230 | 7,575 |
| 7/8 | 4-1/2 | 4,470 | 5,735 | 4,895 | 5,735 | 5,655 | 5,735 | 6,925 | 5,735 | 7,995 | 5,735 |
| 1 | 5-1/2 | 7,140 | 7,110 | 7,820 | 7,110 | 9,030 | 7,110 | 11,060 | 7,110 | 12,770 | 7,110 |
| 1-1/4 | 6-1/2 | 7,380 | 11,540 | 8,080 | 11,540 | 9,330 | 11,540 | 11,430 | 11,540 | 13,195 | 11,540 |

■ - Anchor Pullout/Pryout Strength Controls
 ■ - Concrete Breakout Strength Controls
 ■ - Steel Strength Controls

Tension and Shear Design Strengths for Power-Stud+ SD1 in Uncracked Concrete¹⁻⁶

| Nominal Anchor Diameter (in.) | Nominal Embed. h_{nom} (in.) | Minimum Concrete Compressive Strength | | | | | | | | | |
|-------------------------------|--------------------------------|---------------------------------------|-------------------------|---------------------------|-------------------------|---------------------------|-------------------------|---------------------------|-------------------------|---------------------------|-------------------------|
| | | $f'_c = 2,500$ psi | | $f'_c = 3,000$ psi | | $f'_c = 4,000$ psi | | $f'_c = 6,000$ psi | | $f'_c = 8,000$ psi | |
| | | ϕN_n Tension (lbs.) | ϕV_n Shear (lbs.) | ϕN_n Tension (lbs.) | ϕV_n Shear (lbs.) | ϕN_n Tension (lbs.) | ϕV_n Shear (lbs.) | ϕN_n Tension (lbs.) | ϕV_n Shear (lbs.) | ϕN_n Tension (lbs.) | ϕV_n Shear (lbs.) |
| 1/4 | 1-3/4 | 1,435 | 600 | 1,570 | 600 | 1,690 | 600 | 1,690 | 600 | 1,690 | 600 |
| 3/8 | 2-3/8 | 1,860 | 1,945 | 2,040 | 1,945 | 2,335 | 1,945 | 2,885 | 1,945 | 3,330 | 1,945 |
| 1/2 | 2-1/2 | 2,095 | 2,375 | 2,295 | 2,605 | 2,645 | 3,005 | 3,240 | 3,005 | 3,745 | 3,005 |
| | 3-3/4 | 3,595 | 3,005 | 3,940 | 3,005 | 4,545 | 3,005 | 5,570 | 3,005 | 6,430 | 3,005 |
| 5/8 | 3-3/8 | 3,555 | 4,375 | 3,895 | 4,795 | 4,500 | 5,535 | 5,510 | 5,870 | 6,365 | 5,870 |
| | 4-5/8 | 6,240 | 5,870 | 6,835 | 5,870 | 7,895 | 5,870 | 9,665 | 5,870 | 10,850 | 5,870 |
| 3/4 | 4 | 4,310 | 6,915 | 4,720 | 6,915 | 5,450 | 6,915 | 6,675 | 6,915 | 7,710 | 6,915 |
| | 5-5/8 | 8,075 | 7,575 | 8,845 | 7,575 | 10,215 | 7,575 | 12,510 | 7,575 | 14,250 | 7,575 |
| 7/8 | 4-1/2 | 5,105 | 5,735 | 5,595 | 5,735 | 6,460 | 5,735 | 7,910 | 5,735 | 9,135 | 5,735 |
| 1 | 5-1/2 | 7,140 | 7,110 | 7,820 | 7,110 | 9,030 | 7,110 | 11,060 | 7,110 | 12,770 | 7,110 |
| 1-1/4 | 6-1/2 | 10,935 | 11,540 | 11,980 | 11,540 | 13,830 | 11,540 | 16,940 | 11,540 | 19,560 | 11,540 |

■ - Anchor Pullout/Pryout Strength Controls
 ■ - Concrete Breakout Strength Controls
 ■ - Steel Strength Controls

- Tabular values are provided for illustration and are applicable for single anchors installed in normal-weight concrete with minimum slab thickness, $h_a = h_{min}$, and with the following conditions:
 - C_{a1} is greater than or equal to the critical edge distance, C_{ac} (table values based on $C_{a1} = C_{ac}$).
 - C_{a2} is greater than or equal to 1.5 times C_{a1} .
- Calculations were performed according to ACI 318-14 Chapter 17. The load level corresponding to the controlling failure mode is listed. (e.g. For tension: steel, concrete breakout and pullout; For shear: steel, concrete breakout and pryout). Furthermore, the capacities for concrete breakout strength in tension and pryout strength in shear are calculated using the effective embedment values, h_{ef} , for the selected anchors as noted in the design information tables. Please also reference the installation specifications for more information.
- Strength reduction factors (ϕ) were based on ACI 318-14 Section 5.3 for load combinations. Condition B is assumed.
- Tabular values are permitted for static loads only, seismic loading is not considered with these tables.
- For designs that include combined tension and shear, the interaction of tension and shear loads must be calculated in accordance with ACI 318-14 Chapter 17.
- Interpolation is not permitted to be used with the tabular values. For intermediate base material compressive strengths please see ACI 318-14 Chapter 17. For other design conditions including seismic considerations please see ACI 318-14 Chapter 17.

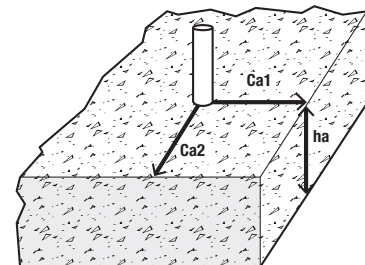

ORDERING INFORMATION

MECHANICAL ANCHORS

POWER-STUD® + SD1
Wedge Expansion Anchor

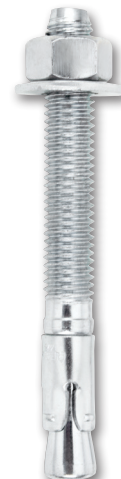

Power-Stud+ SD1 (Carbon Steel Body and Expansion Clip)

| Cat. No. | Anchor Size | Thread Length | Box Qty. | Carton Qty. | Wt./100 (lbs.) | Suggested ANSI Carbide Drill Bit Cat. No. | | | | |
|----------|---------------|---------------|----------|-------------|----------------|---|----------|---------|---------------------|--------------------|
| | | | | | | Full Head SDS-Plus | SDS-Plus | SDS-Max | Hollow Bit SDS-Plus | Hollow Bit SDS-Max |
| 7400SD1 | 1/4" x 1-3/4" | 3/4" | 100 | 600 | 3 | DW5517 | DW5416 | - | - | - |
| 7402SD1 | 1/4" x 2-1/4" | 1-1/4" | 100 | 600 | 4 | DW5517 | DW5417 | - | - | - |
| 7404SD1 | 1/4" x 3-1/4" | 2-1/4" | 100 | 600 | 5 | DW5517 | DW5417 | - | - | - |
| 7410SD1 | 3/8" x 2-1/4" | 7/8" | 50 | 300 | 8 | DW5527 | DW5427 | - | - | - |
| 7412SD1 | 3/8" x 2-3/4" | 1-3/8" | 50 | 300 | 9 | DW5527 | DW5427 | - | - | - |
| 7413SD1 | 3/8" x 3" | 1-5/8" | 50 | 300 | 10 | DW5527 | DW5427 | - | - | - |
| 7414SD1 | 3/8" x 3-1/2" | 2-1/8" | 50 | 300 | 12 | DW5527 | DW5427 | - | - | - |
| 7415SD1 | 3/8" x 3-3/4" | 2-3/8" | 50 | 300 | 13 | DW5527 | DW5427 | - | - | - |
| 7416SD1 | 3/8" x 5" | 3-5/8" | 50 | 300 | 15 | DW55300 | DW5429 | - | - | - |
| 7417SD1 | 3/8" x 7" | 5-5/8" | 50 | 300 | 21 | DW55300 | DW5429 | - | - | - |
| 7420SD1 | 1/2" x 2-3/4" | 1" | 50 | 200 | 19 | DW5537 | DW5437 | DW5803 | DWA54012 | - |
| 7422SD1 | 1/2" x 3-3/4" | 2" | 50 | 200 | 23 | DW5537 | DW5437 | DW5803 | DWA54012 | - |
| 7423SD1 | 1/2" x 4-1/2" | 2-3/4" | 50 | 200 | 27 | DW5539 | DW5438 | DW5803 | DWA54012 | - |
| 7424SD1 | 1/2" x 5-1/2" | 3-3/4" | 50 | 150 | 30 | DW5539 | DW5438 | DW5803 | DWA54012 | - |
| 7426SD1 | 1/2" x 7" | 5-1/4" | 25 | 100 | 38 | DW5539 | DW5438 | DW5803 | DWA54012 | - |
| 7427SD1 | 1/2" x 8-1/2" | 6-3/4" | 25 | 100 | 44 | DW5539 | DW5439 | DW5804 | DWA54012 | - |
| 7428SD1 | 1/2" x 10" | 8-1/4" | 25 | 100 | 53 | DW5539 | DW5439 | DW5804 | DWA54012 | - |
| 7430SD1 | 5/8" x 3-1/2" | 1-1/2" | 25 | 100 | 37 | - | DW5446 | DW5806 | DWA54058 | DWA54058 |
| 7432SD1 | 5/8" x 4-1/2" | 2-1/2" | 25 | 100 | 43 | - | DW5446 | DW5806 | DWA54058 | DWA54058 |
| 7433SD1 | 5/8" x 5" | 3" | 25 | 100 | 47 | - | DW5446 | DW5806 | DWA54058 | DWA54058 |
| 7434SD1 | 5/8" x 6" | 4" | 25 | 75 | 53 | - | DW5446 | DW5806 | DWA54058 | DWA54058 |
| 7436SD1 | 5/8" x 7" | 5" | 25 | 75 | 60 | - | DW5447 | DW5806 | DWA54058 | DWA54058 |
| 7438SD1 | 5/8" x 8-1/2" | 6-1/2" | 25 | 50 | 70 | - | DW5447 | DW5809 | DWA54058 | DWA54058 |
| 7439SD1 | 5/8" x 10" | 8" | 25 | 75 | 87 | - | DW5447 | DW5809 | DWA54058 | DWA54034 |
| 7440SD1 | 3/4" x 4-1/4" | 1-3/4" | 20 | 60 | 63 | - | DW5453 | DW5810 | DWA54034 | DWA54034 |
| 7441SD1 | 3/4" x 4-3/4" | 2-1/4" | 20 | 60 | 68 | - | DW5453 | DW5810 | DWA54034 | DWA54034 |
| 7442SD1 | 3/4" x 5-1/2" | 3" | 20 | 60 | 76 | - | DW5453 | DW5810 | DWA54034 | DWA54034 |
| 7444SD1 | 3/4" x 6-1/4" | 3-3/4" | 20 | 60 | 83 | - | DW5455 | DW5810 | DWA54034 | DWA54034 |
| 7446SD1 | 3/4" x 7" | 4-1/2" | 20 | 60 | 91 | - | DW5455 | DW5810 | DWA54034 | DWA54034 |
| 7448SD1 | 3/4" x 8-1/2" | 6" | 10 | 40 | 107 | - | DW5455 | DW5812 | DWA54034 | DWA54034 |
| 7449SD1 | 3/4" x 10" | 7-1/2" | 10 | 30 | 123 | - | DW5455 | DW5812 | DWA54034 | DWA54034 |
| 7451SD1 | 3/4" x 12" | 9-1/2" | 10 | 30 | 144 | - | DW5456 | DW5812 | DWA54034 | DWA54034 |
| 7450SD1 | 7/8" x 6" | 2-3/4" | 10 | 20 | 128 | - | - | DW5815 | - | DWA54078 |
| 7452SD1 | 7/8" x 8" | 4-3/4" | 10 | 40 | 161 | - | - | DW5815 | - | DWA54078 |
| 7454SD1 | 7/8" x 10" | 6-3/4" | 10 | 30 | 187 | - | - | DW5816 | - | DWA54078 |
| 7461SD1 | 1" x 6" | 2-3/8" | 10 | 30 | 168 | - | - | DW5818 | - | DWA58001 |
| 7463SD1 | 1" x 9" | 5-3/8" | 10 | 30 | 234 | - | - | DW5819 | - | DWA58001 |
| 7465SD1 | 1" x 12" | 8-3/8" | 5 | 15 | 307 | - | - | DW5819 | - | DWA58001 |
| 7473SD1 | 1-1/4" x 9" | 4-3/4" | 5 | 15 | 374 | - | - | DW5820 | - | - |
| 7475SD1 | 1-1/4" x 12" | 7-3/4" | 5 | 15 | 476 | - | - | DW5825 | - | - |

Tie Wire Power-Stud+ SD1 (Carbon Steel Body and Expansion clip)

| Cat. No. | Anchor Size | Thread Length | Box Qty. | Carton Qty. | Wt./100 (lbs.) |
|----------|-------------|---------------|----------|-------------|----------------|
| 7409SD1 | 1/4" x 2" | N/A | 100 | 500 | 3 |



Shaded catalog numbers denote sizes which are less than the minimum standard anchor length for strength design.

The published size includes the diameter and the overall length of the anchor.

All anchors are packaged with nuts and washers (not including tie wire version).

See the DEWALT website or Buyers Guide for additional information on carbide drill bits.

A manual hand pump is available (Cat. No. 08280).

Hollow drill bits must be used with a dust extraction vacuum (Cat. No. DW012).